



  
UGEAR'S®

Mechanical models

**Model «Hurdy-Gurdy»  
Модель «Харді Гарді»**

DEU Modell «Drehleier». FRA Modèle «Vielle à roue».  
POL Model «Lira korbowa». SPA Modelo «Hurdy-Gurdy».  
ITA Modello «Ghironda». TUR Model «Hurdy-Gurdy».  
RUS Модель «Харди-Гарди». KOR 허디거디. CHI «论擦提琴»模型

**Assembly instructions  
Інструкція зі складання**

DEU Aufbauanleitung. FRA Notice d'assemblage. POL Instrukcja montażu.  
SPA Instrucciones de montaje. ITA Istruzioni di montaggio. TUR Kurulum talimatı.  
RUS Инструкция по сборке. KOR 조립 설명서. CHI 装配说明书

**ENG****Manual:**

Remove model parts from the hanger board as illustrated below. Careful not to break parts. If a part does not remove easily, carefully cut it out with a knife. This model is intended for self-assembly without glue. If you have difficulty installing the axles, try waxing them with a regular candle. All moving parts can also be waxed during assembly to reduce friction when operating the model.

**TUR****Kurulum talimatı:**

Şemada işaretlenen parçaları tahtadan çıkarın. Kırılmamasına dikkat ediniz. Parça çıkarılmıyorsa bağlantı yerleri bıçakla kesiniz. Konstruksyon, yapıştırıcı kullanmadan yapılmaktadır. Tahta dingilini (kürdan) deliğin içine yerleştirmede zorluk çekiyorsanız önceden dingile veya parçalara mum sürünüz. Hareketli parçaların daha iyi kayması için kurulum sırasında parçalara mum sürünüz.

**UKR****Інструкція зі складання:**

Витягніть з дошки позначені на схемі деталі. Намагайтеся їх не зламати. Якщо деталь не виймається, надсічіть перемички ножом. Конструкція збирається без клею. У разі виникнення труднощів з протягуванням зубочистки (вісі) в отвір потріть зубочистку об звичайну свічку. Також можна змастити свічкою всі деталі механізму, що рухаються, щоб зменшити тертя при обертанні.

**RUS****Инструкция по сборке:**

Вынимайте из доски обозначенные на схеме детали. Старайтесь их не сломать. Если деталь не извлекается, надрежьте перемычки ножом. Конструкция собирается без клея. Если возникли трудности с установкой деревянной оси, перед установкой потрите детали об обычную свечу. Для лучшего скольжения смазывайте движущиеся детали механизма обычной свечой во время сборки.

**DEU****Aufbauanleitung:**

Bitte die in der Zeichnung angegebenen Teile aus der Platte herausnehmen. Versuchen Sie bitte diese nicht zu brechen. Wenn sich ein Teil nicht herausnehmen lässt, schneiden Sie die Stege mit dem Messer leicht an. Das Modell wird ohne Klebstoffe zusammgebaut. Lässt sich eine Achse nur schwer in eine Öffnung einführen, reiben Sie diese mit einer Kerze etwas ein. Für besseres Gleiten schmieren Sie alle beweglichen Teile mit einer Kerze.

**KOR****조립 설명:**

부품이 손상되지 않도록 주의하여 보드에서 떼어냅니다. 만약 부품이 잘 떨어지지 않으면 연결 부분을 칼로 절단 한 후 떼어내면 쉽게 떼어 낼 수 있습니다. 본 제품은 접착제가 없이 조립이 가능하도록 설계되어 있습니다. 만약 축이 잘 끼워지지 않는 경우 양초를 축에 바른 후 끼워보세요. 모든 구동 부위는 제품 구동 시 원활한 작동이 가능하도록 조립 과정에서 윤활제(양초)양초를 발라 주세요.

**FRA****Notice d'assemblage:**

Faites sortir de la planche les pièces comme indiquées sur le schéma. Tâchez de ne pas les casser. Si la pièce ne sort pas, incisez les collages/fixations avec un couteau. La construction est à assembler sans colle. Si il est difficile d'introduire l'axe en bois dans l'orifice, frottez au préalable l'axe ou les pièces contre une bougie. Pour améliorer le glissement, traitez les pièces de frottement mobiles du mécanisme avec une bougie au cours d'assemblage.

**CHI****装配说明**

将模型部件按插插图示，从胶合板取下。小心不要损坏件。如果取下时候有难度，请用小刀小心的切割连接点。这个产品不需要胶水粘接。如果安装转轴的时候有难度，请用普通的蜡加以润滑。所有的转动部分也需要打蜡润滑。

**POL****Instrukcja montażu:**

Delikatnie wyciągaj z deseczki wskazane w schemacie detale, starając się nie połamać elementów. Jeśli detal nie poddaje się, podetnij wiązadła nożem. Konstrukcje składa się bez kleju. Jeśli napotkasz trudności z instalacją drewnianej osi w otwór, potrzyj na początku oś lub detale o woskową świecę. Dla lepszego poślizgu polecano smarowanie ruchomych części mechanizmu zwykłą świecą podczas montażu.

**SPA****Instrucciones de montaje:**

Saque de la tabla las piezas marcadas en el esquema. Trate de no romperlas. Si una pieza no se saca, haga una incisión. La construcción va sin pegamento. Si tiene dificultades con la instalación del eje de madera en un agujero, frote primero el eje o las piezas contra una vela. Para un mejor deslizamiento, lubrique durante el montaje las piezas móviles del mecanismo con una vela común.

**ITA****Istruzioni di montaggio:**

Estrarre dal telaio i particolari indicati nello schema. Fare attenzione a non romperli. Se un particolare non si stacca, tagliare delicatamente gli elementi di collegamento con un coltello. L'assieme viene realizzato senza colla. In caso di difficoltà nell'inserimento di un perno in legno, è necessario sfregare il perno o il particolare con un po' di cera. Per uno scorrimento migliore incerare le parti mobili del meccanismo durante l'assemblaggio.

**ENG Warning! UKR Увага! DEU Achtung! FRA Attention! POL Uwaga! SPA Precaución! ITA Attenzione! TUR Dikkat! RUS Внимание! KOR 주의! CHI 注意!**



**ENG** Do not use a lighted candle! **UKR** Не підпалювати! **DEU** Nicht anzünden! **FRA** Ne pas brûler! **POL** Nie podpalać! **SPA** ¡No encender! **ITA** Non dare fuoco! **TUR** Yakmayınız! **RUS** Не поджигать! **KOR** 불이 붙은 초를 이용하지 마세요! **CHI** 请勿点燃，请勿靠近火源！



**ENG** Caution! Axles have sharp points! **UKR** Обережно! Гострі деталі! **DEU** Vorsicht! Spitze Teile! **FRA** Attention: certaines pièces sont pointues! **POL** Ostrożnie! Ostre części! **SPA** ¡Atención! Piezas afiladas! **ITA** Attenzione! Particolari appuntiti! **TUR** Dikkat! Keskin parçalar! **RUS** Осторожно! Острые детали! **KOR** 축의 뾰족한 부분에 주의하세요! **CHI** 尖锐部件！



ENG Wax the part with a regular candle (rub with a candle). UKR Змастіть деталь звичайною свічкою (потріть об свічку).  
DEU Reiben Sie das Teil mit einer einfachen Kerze etwas ein. FRA Lubrifiez la pièce avec une bougie ordinaire (frottez contre la bougie). POL Przesmaruj zwykłą świecą. SPA Engrase la pieza con una vela común (frote con una vela). ITA Incerare il componente (Sfregare con la cera). TUR Parçaya sade mum sürünüz. RUS Смажьте деталь обычной свечкой (потрите о свечку). KOR 표시된 부분에 윤활을 위해 초를 칠해 주세요. CHI 用普通蜡烛涂抹润滑部件。



ENG Sand to remove burrs. UKR Видалить задирки. DEU Grate entfernen. FRA Éliminez les bavures. POL Usuń zadziory. SPA Quite las rebabas. ITA Togliere le bave.  
TUR Çapakları çıkartınız. RUS Удалите заусенцы. KOR 거친 부분을 다듬어 주세요. CHI 磨掉毛刺



ENG Rosin. Brush over with rosin. UKR Канифоль. Натерти поверхню канифоллю. DEU Kolophonium. Mit Kolophonium einreiben. FRA Colophane. Frotter colophane. POL Kalafonia. Przetrzeć kalafonią. SPA La colofonia. Frotar con la colofonia.  
ITA Colofonia. Spazzolare con colofonia. TUR Reçine. Öğütülmüş reçine. RUS Канифоль. Натереть поверхность канифоллю.  
KOR 송진가루. 송진가루를 칠할 것. CHI 松香 刷过松香



ENG Do not fully press the outer parts (structural frame) together until checking for fit and alignment of internal parts. UKR Деякий час не притискайте сильно деталі (рамки конструкції). DEU Drücken Sie die Teile (die Rahmen der Konstruktion) momentan nicht stark. FRA Ne pas forcer sur les pièces (cadre de la construction). POL Tymczasowo nie dociskaj elementów (ramy konstrukcji). SPA No presione temporalmente con fuerza las piezas (marco de la estructura).  
ITA Non stringere provvisoriamente i componenti con forza (base della costruzione). TUR Bir süre için parçaları (yapı çerçevelerini) fazla sıkmayın. RUS Временно сильно не прижимайте детали (рамки конструкции). KOR 아직은 외부의 틀을 완전히 눌러서 고정하면 안됩니다. 다른 부품을 먼저 끼우세요. CHI 在检查内部零件的配合和对准之前, 请暂时不要将外部零件 (结构框架) 完全压在一起。



ENG Press the parts as far as they will go. UKR Притисніть деталі до упору. DEU Drücken Sie die Teile bis zum Anschlag. FRA Pressez les pièces à fond.  
POL Przyciśnij element, aż do oporu. SPA Pulse para detener las piezas. ITA Stingere bene i componenti. TUR Parçaları sonuna kadar sıkıştırınız.  
RUS Прижмите детали до упора. KOR 부품을 양쪽에서 눌러서 고정해 주세요. CHI 用力紧密结合部件



ENG Pay attention. Check for correct orientation or positioning. UKR Зверніть увагу. Перевірте розташування елемента. DEU Bitte Beachten. Prüfen Sie die Einbaulage des Elementes. FRA Faites attention. Vérifiez la disposition de l'élément. POL Zwróć uwagę. Sprawdź lokalizację elementu. SPA Atención. Compruebe la situación del elemento. ITA Prestare attenzione. Controllare la posizione del componente. TUR Dikkat. Elemanın yerleşimini kontrol ediniz. RUS Обратите внимание. Проверьте расположение элемента. KOR 방향 또는 위치에 주의해서 조립해 주세요. CHI 注意! 检查部件方向和位置



ENG Cut crosspieces before removing the part from the board. UKR Обріжте перемички перед витяганням деталі. DEU Schneiden Sie die Stege ein, bevor Sie das Teil rausnehmen. FRA Découpez les fixations avant de retirer les pièces. POL Obetnij uszczelnienia przed wyjmowaniem elementu. SPA Corte los puentes antes de extraer la pieza. ITA Tagliare gli elementi di collegamento prima di estrarre i particolari. TUR Parçaları çıkarmadan önce bağlantı yerlerini kesiniz. RUS Обрежьте соединительные перемычки перед выниманием детали. KOR 부품을 떼어내기 전, 연결 부분을 잘라 주세요. CHI 在取下部件前切断连接点

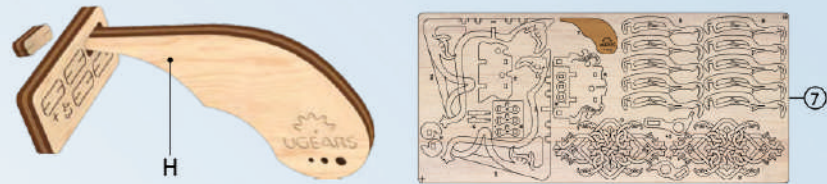

ENG This is not a structural component; it is a tool for measurement and assembly. UKR Це не деталь конструкції, а допоміжний інструмент для складання або вимірювання відстаней.  
DEU Es ist kein Teil der Konstruktion, sondern ein Hilfselement für den Zusammenbau oder für das Messen der Abstände. FRA Cette pièce ne fait pas partie de la construction mais constitue un outil annexe pour l'assemblage ou la mesure des distances. POL To nie detal konstrukcji, a pomocnicze narzędzie dla montażu i wymiaru odległości. SPA No es una pieza de la construcción sino un instrumento auxiliar para montar o para medir distancias. ITA Non è un componente del modello, ma un'attrezzatura aggiuntiva per il montaggio o il rilievo delle quote. TUR Yapı parçası değil. Kurulum yapmak veya mesafe ölçmek amacıyla kullanılan yardımcı alettir. RUS Это не деталь конструкции, а вспомогательный инструмент для сборки или измерения расстояний. KOR 이 부품은 조립을 위한 부품이 아니고 조립을 돕거나 측정을 위한 도구입니다. CHI 这不是装配零部件, 是一种测量及安装辅助工具。



ENG The part should be easily rotated (moved). UKR Деталь повинна легко крутитися (рухатися).  
DEU Der Teil soll leicht gedreht (bewegt) werden. FRA La pièce doit tourner (se déplacer) aisément.  
POL Element powinien łatwo się kręcić (poruszać się). SPA La pieza debe ser fácil de girar (mover).  
ITA Il componente deve girare (muoversi) facilmente. TUR Parça kolayca dönmeli (hareket etmeli).  
RUS Деталь должна легко крутиться (двигаться). KOR 할거 쉽게 움직일 수 있어야합니다. CHI 此部件应灵活转动



ENG Auxiliary model "hammer". Use for rigid connections. UKR Допоміжна модель "Молоток". Застосовувати для жорстких з'єднань. DEU Hilfsmittel Multitool "Zange". Für eine starre Verbindung verwenden. FRA Pièce-outil "marteau". À utiliser sur les joints. POL Model pomocniczy "młoteczek". Dla sztywnych połączeń. SPA . Modelo auxiliar "martillo". Aplicar para las conexiones rígidas. ITA Modello ausiliario "martello". Da utilizzare per connessioni rigide. TUR Yardımcı model "çekiç". Sert bağlantılar için kullanın. RUS Вспомогательная модель "Молоток". Использовать для жестких соединений. KOR 부가 모델 "해머". 견고한 결합을 위해 사용. CHI 辅助性模型 "木槌" 使用刚性连接

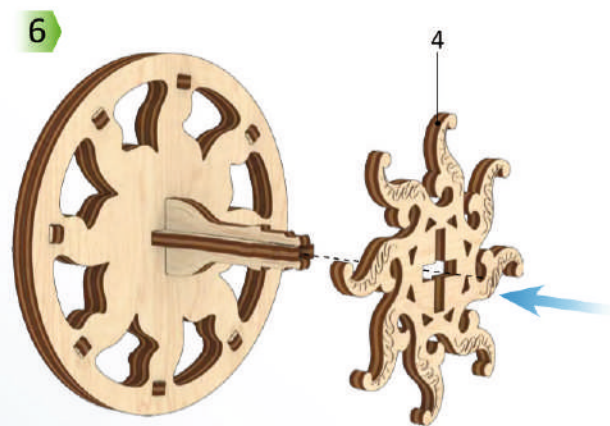
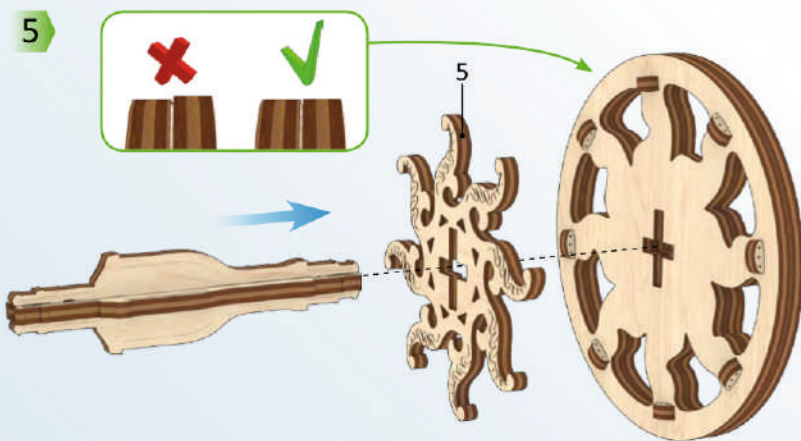
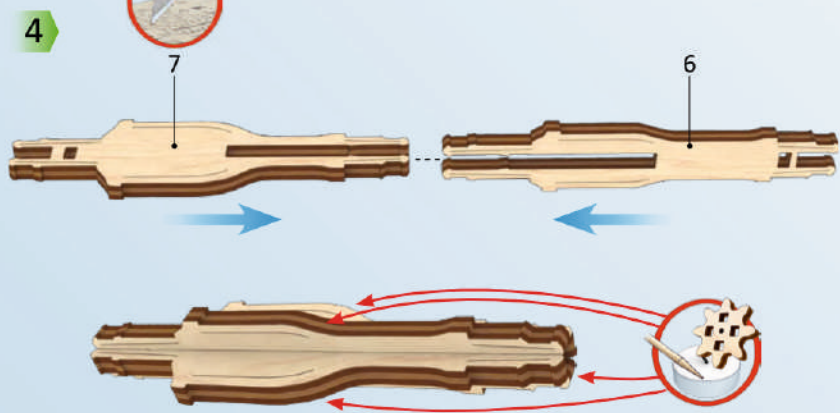
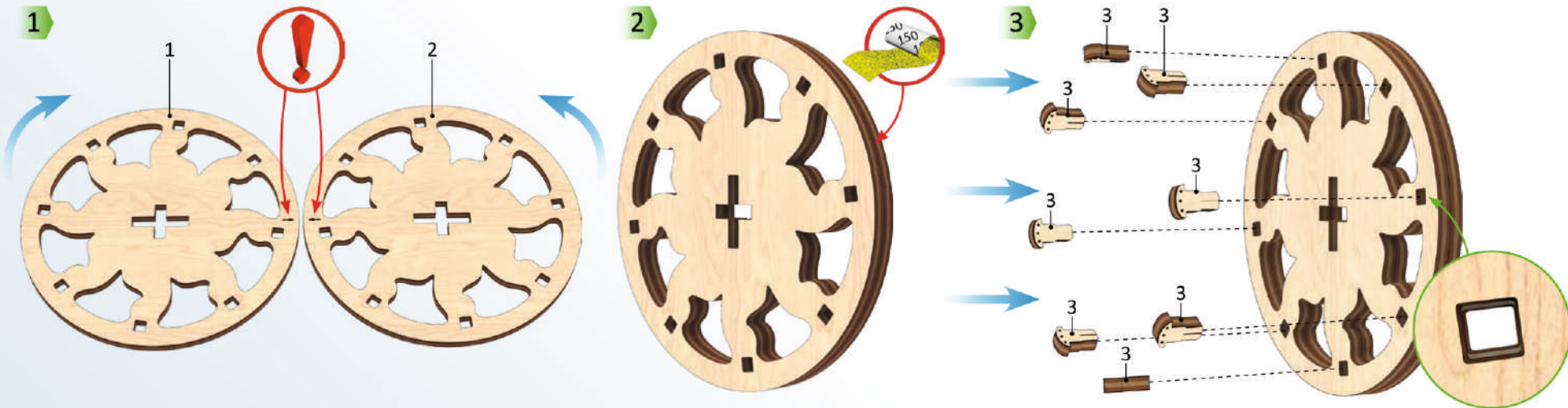
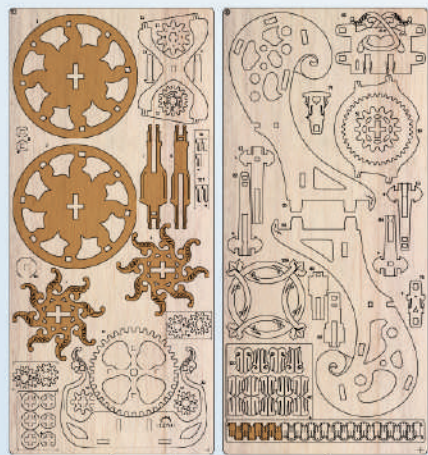



1

3

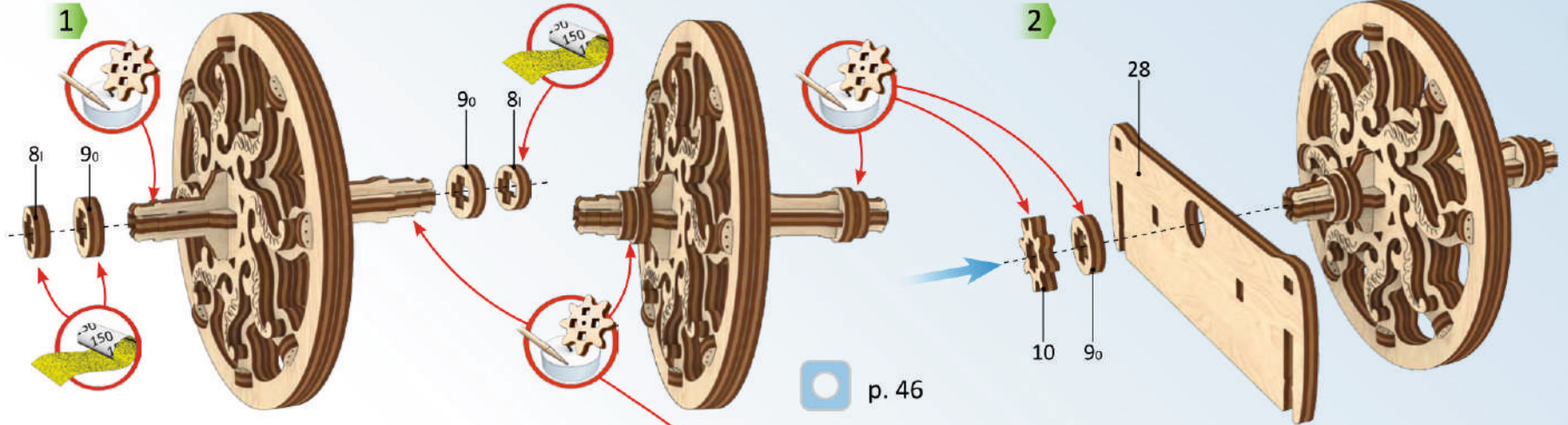

1

2

p. 46

3

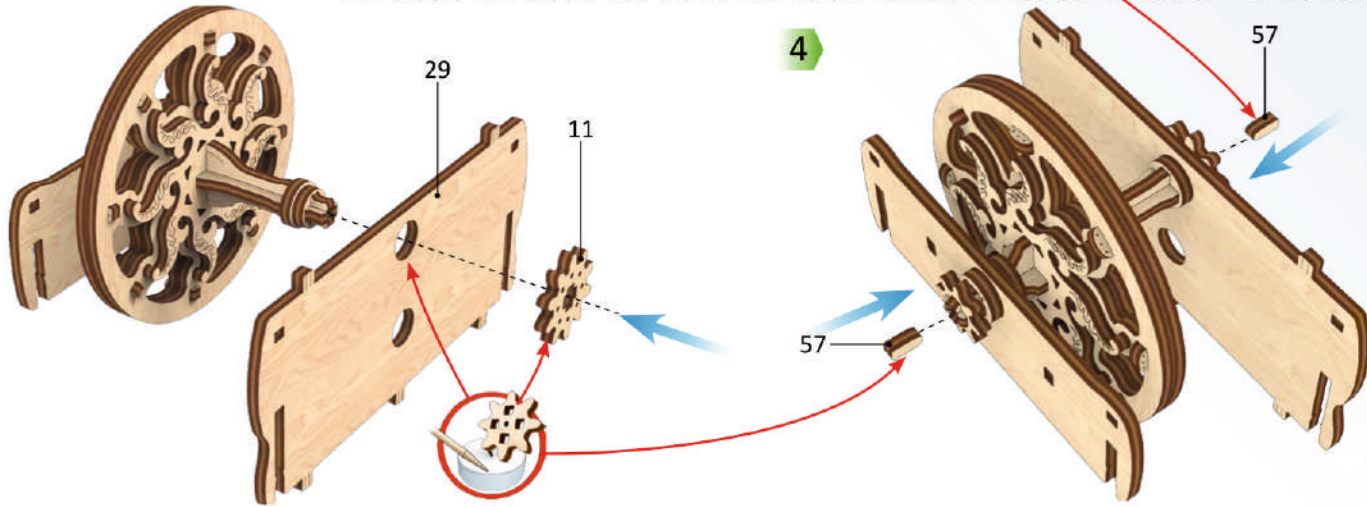

4

5

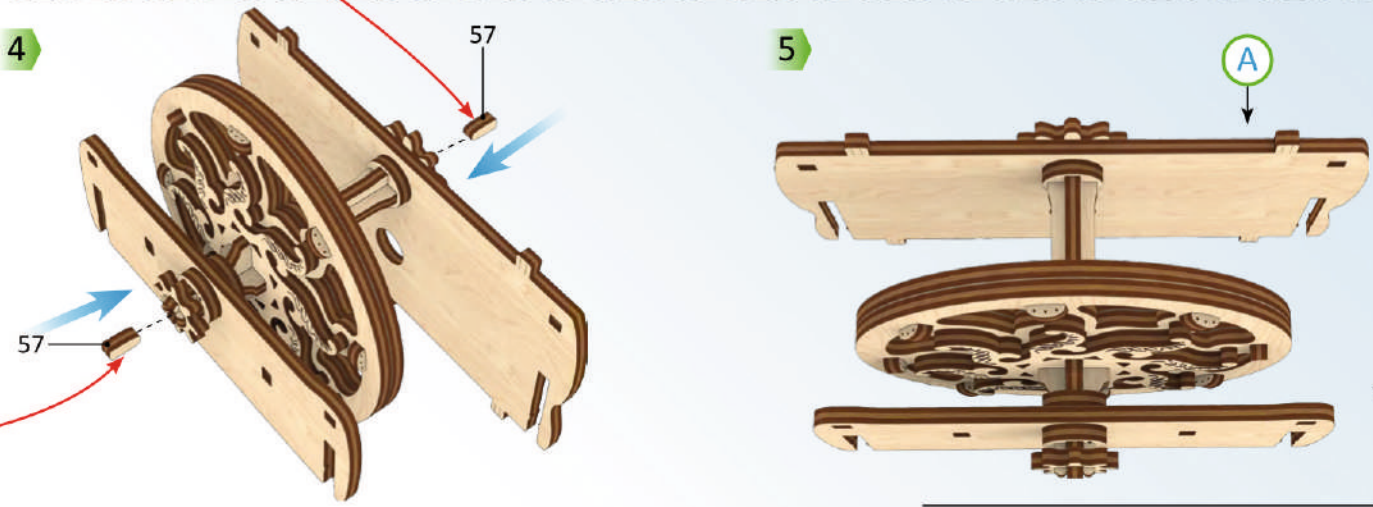

5

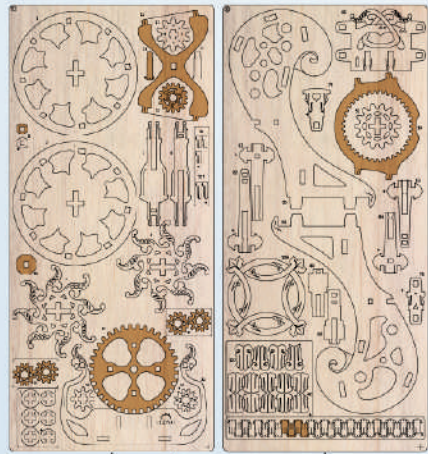

1

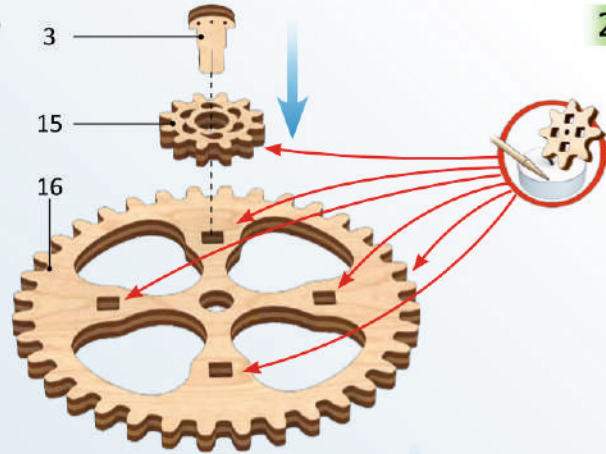

2

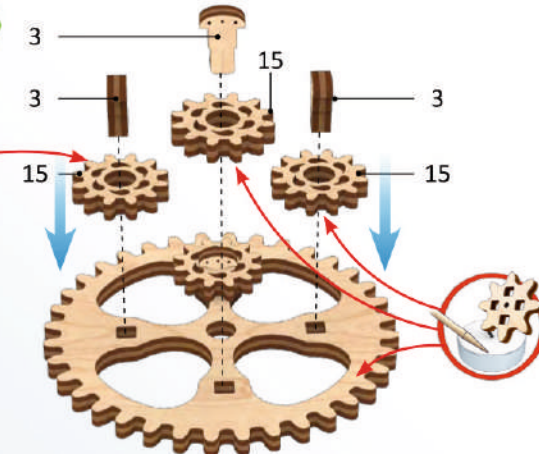

3



4

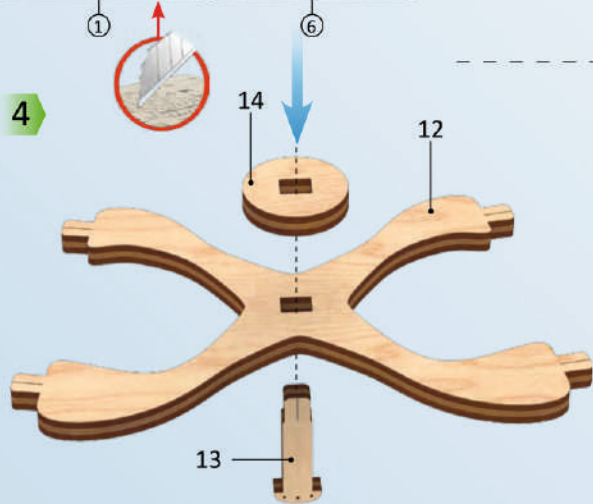

5

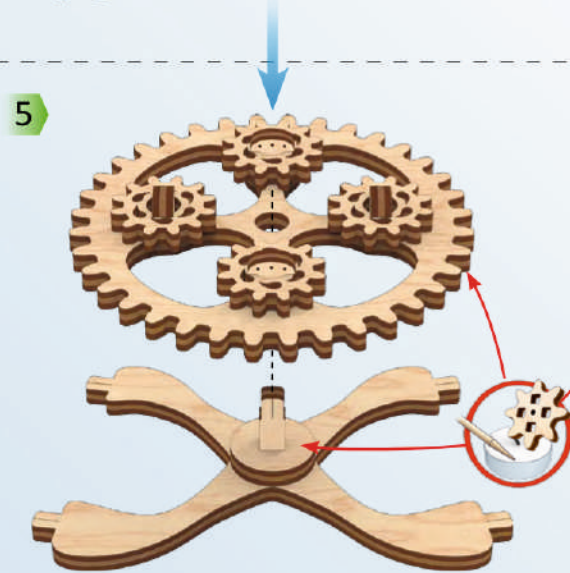

6

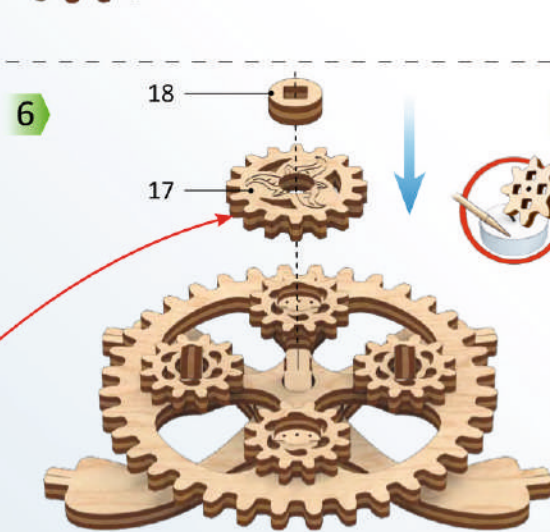

7

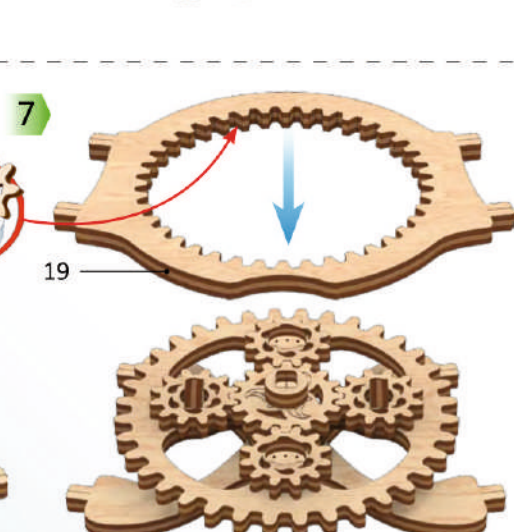

6

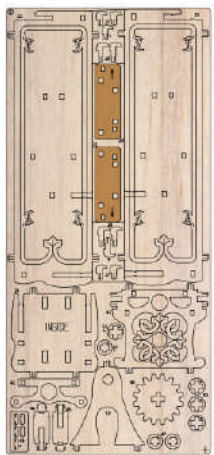

2

1



2

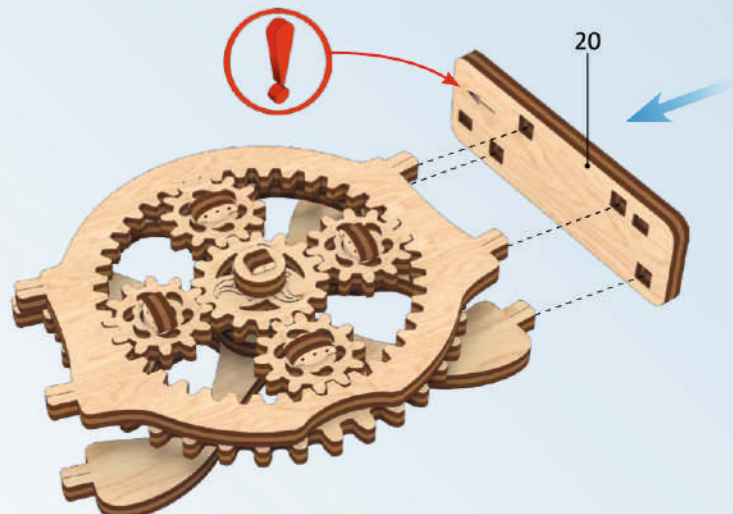

3

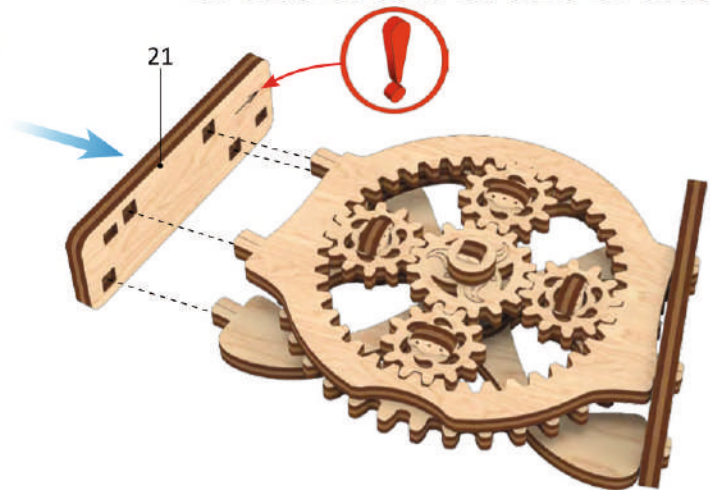

4

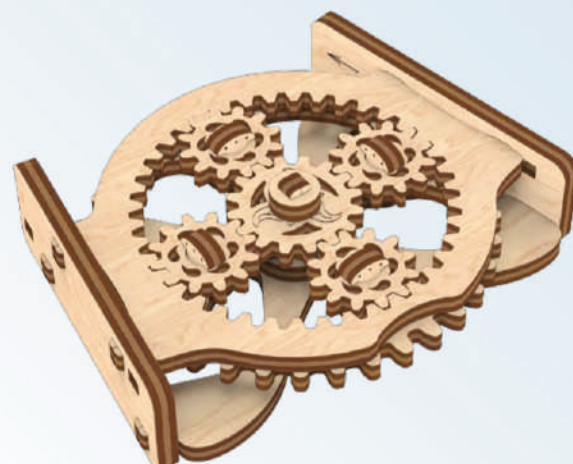
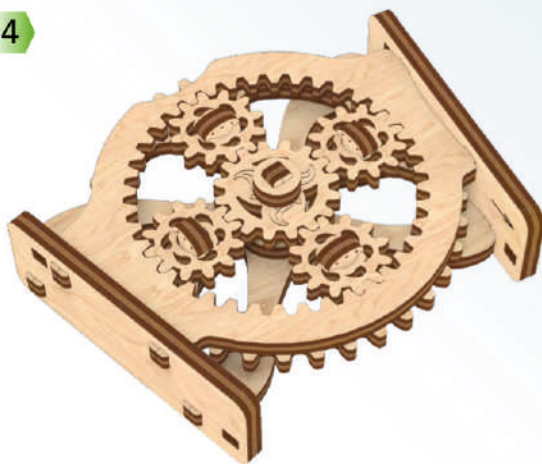

B



7

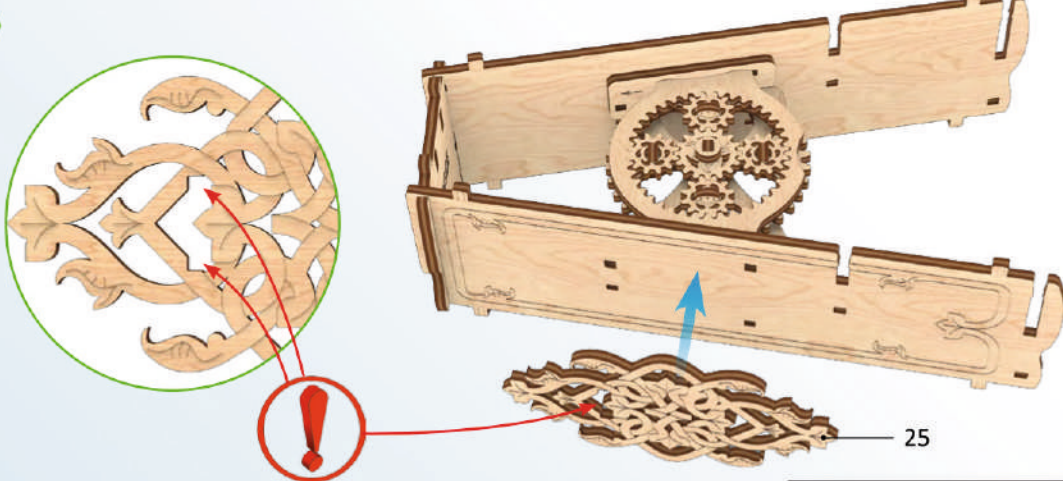
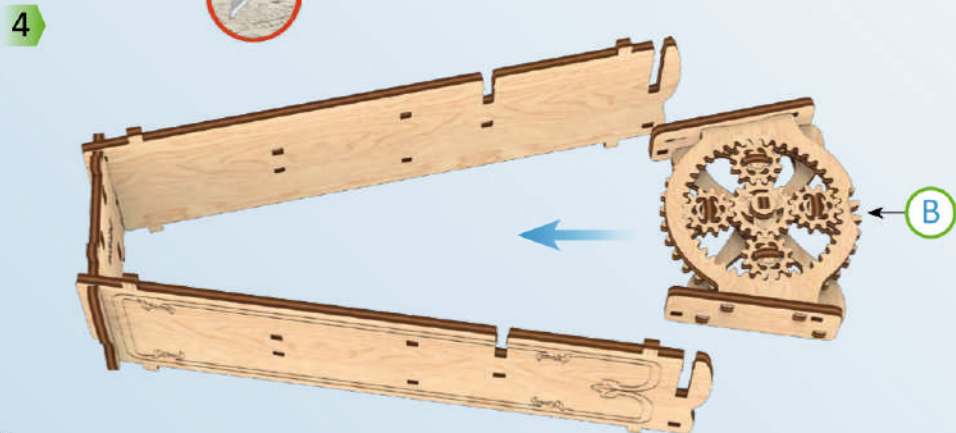
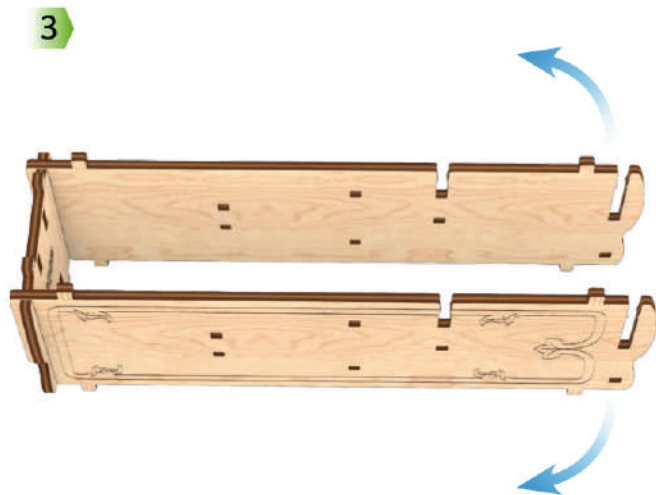
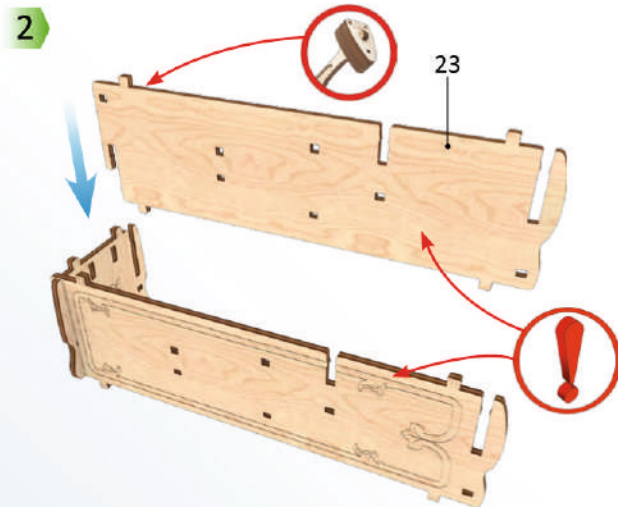
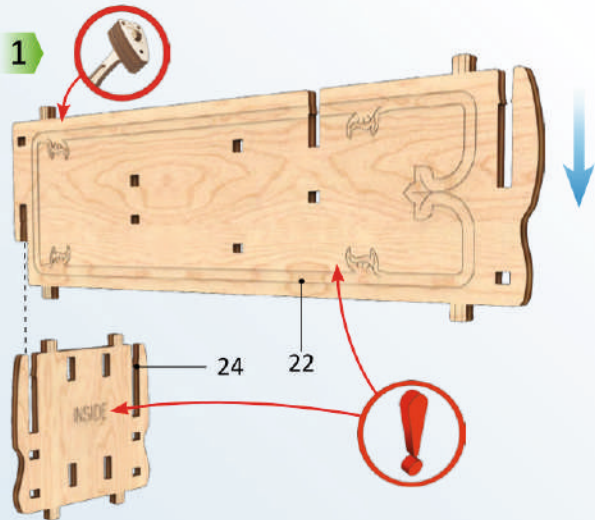
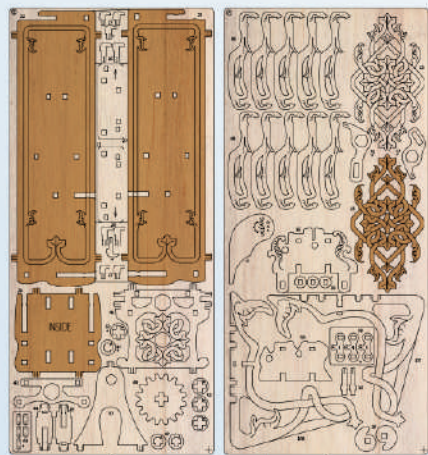



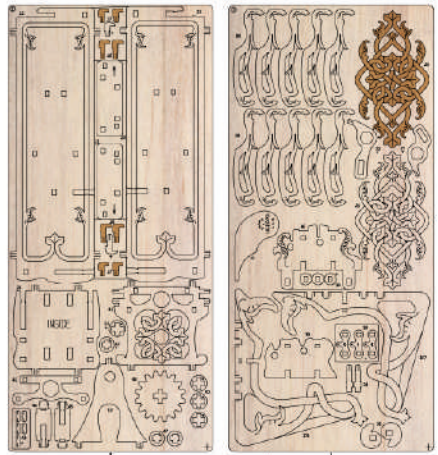

1

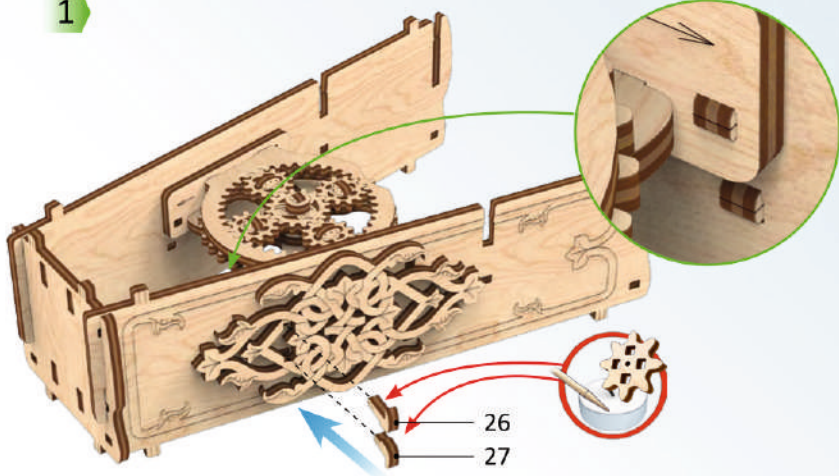

2

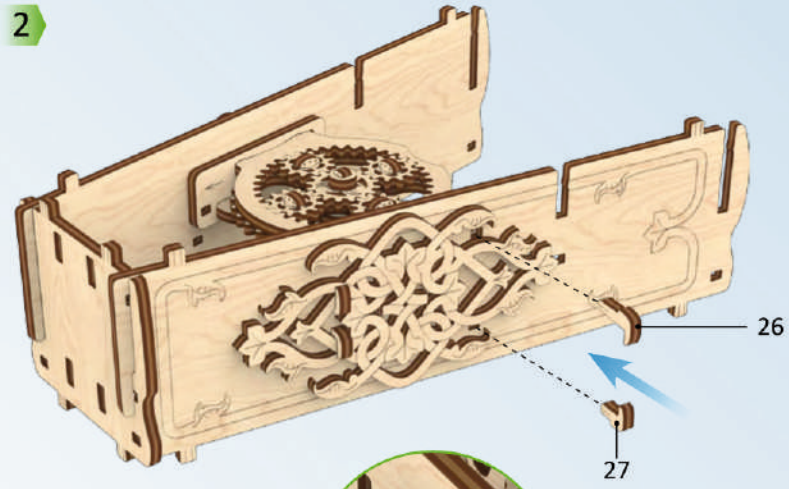

3

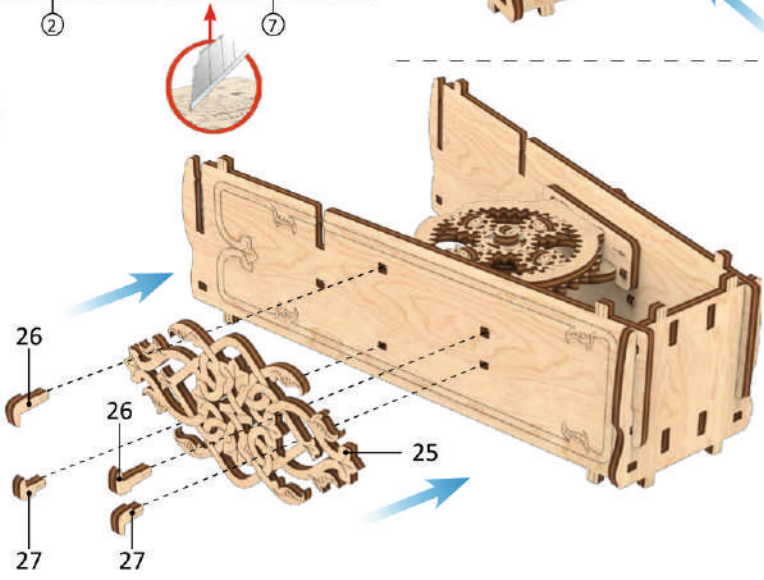

4

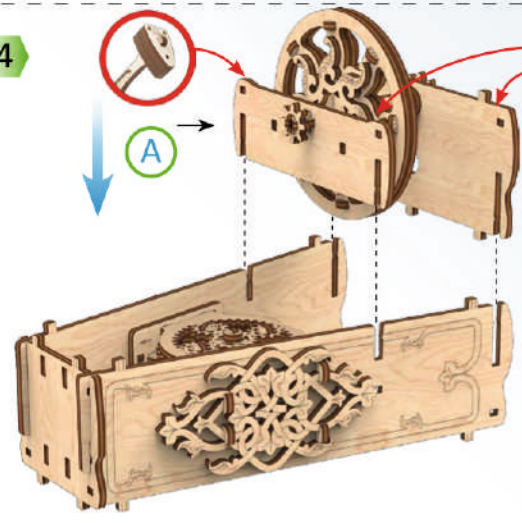

5

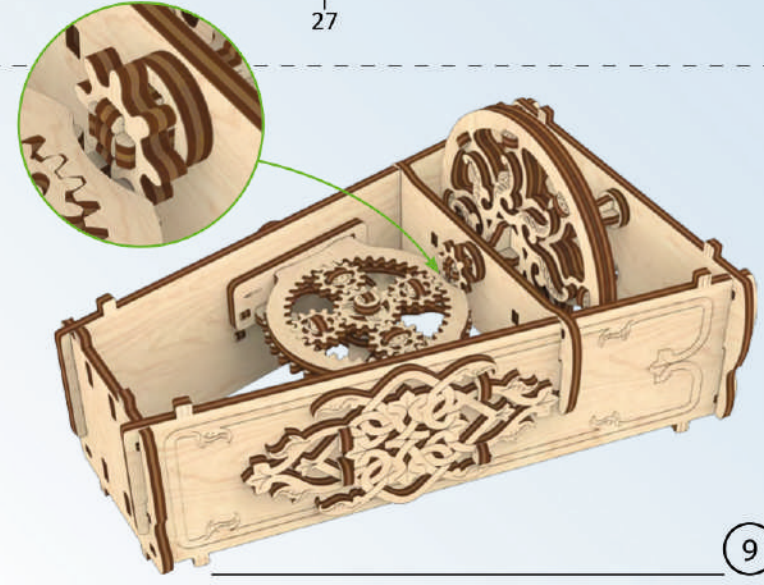

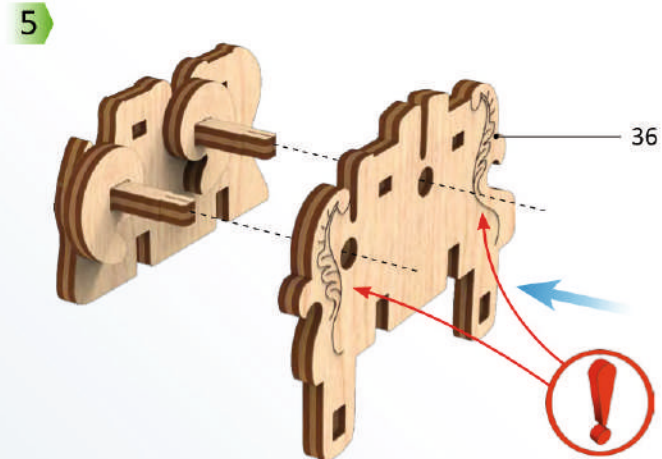
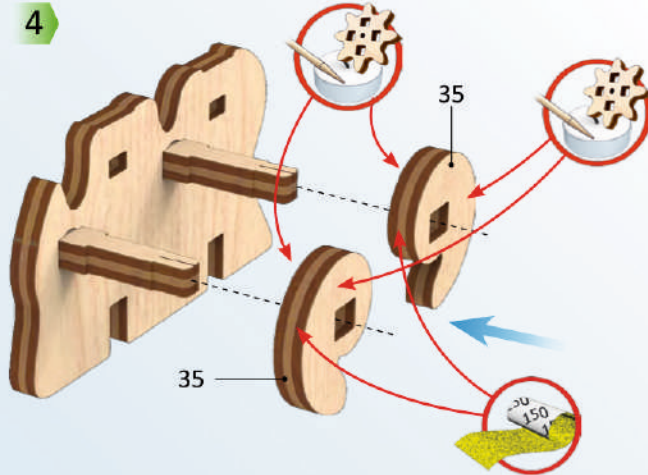
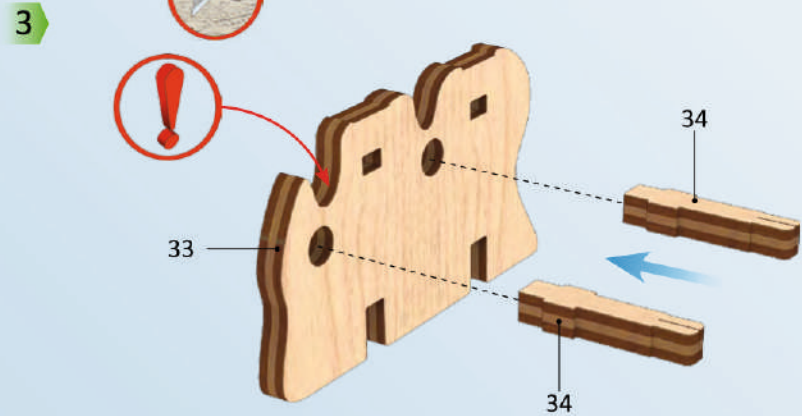
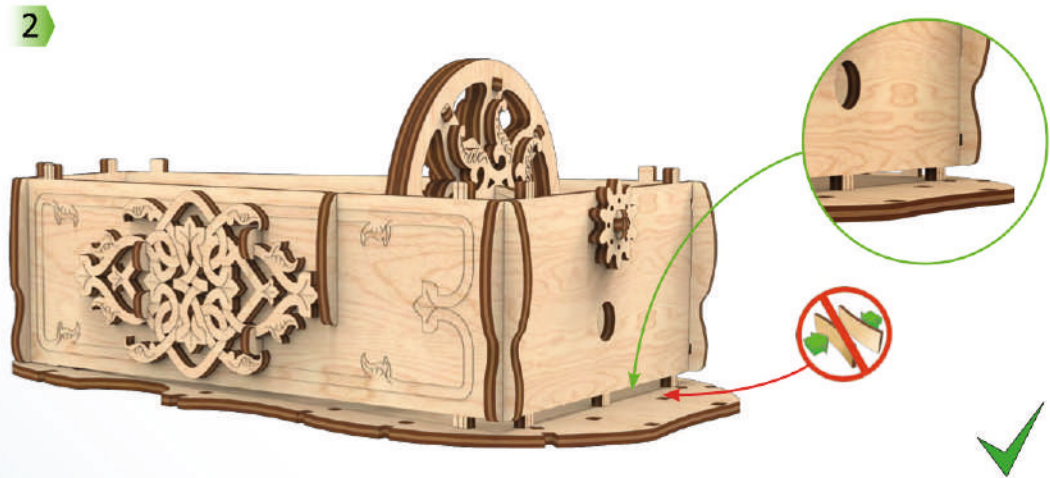
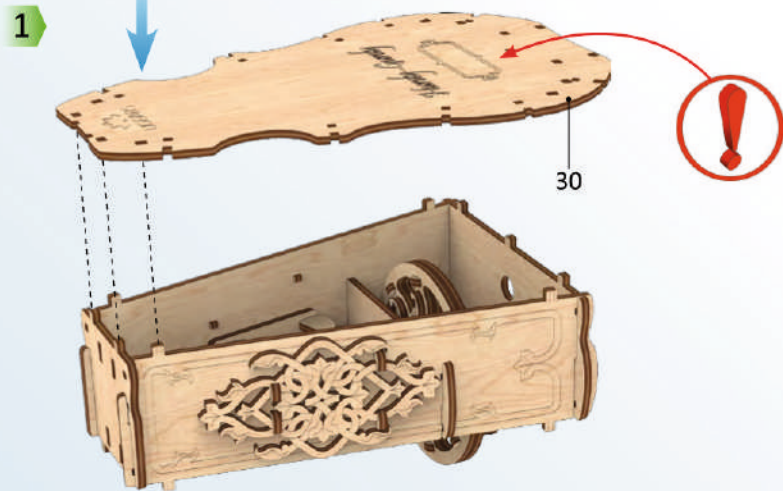
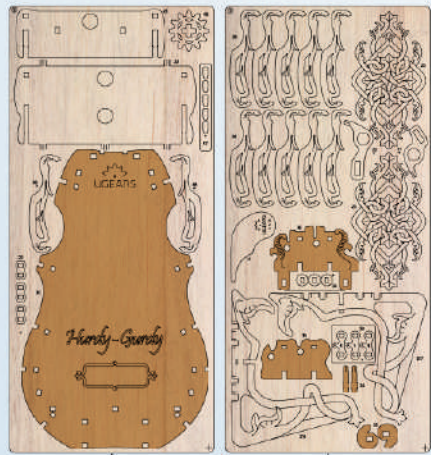

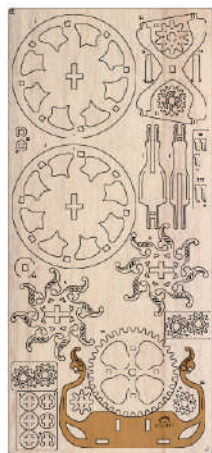

1



4

1



37

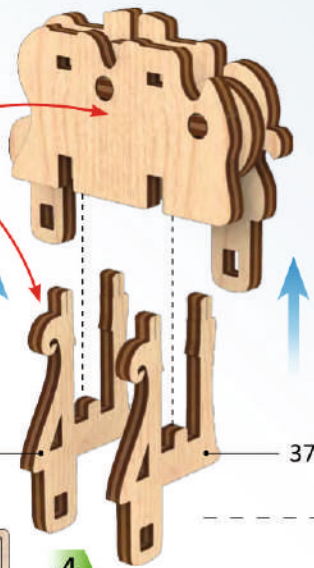

2

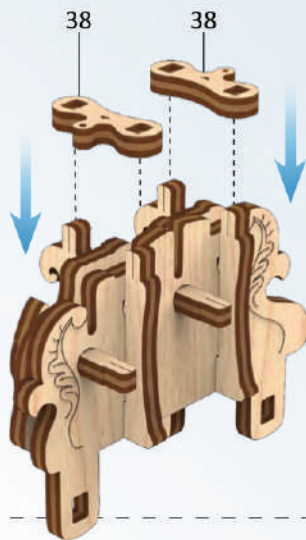

3

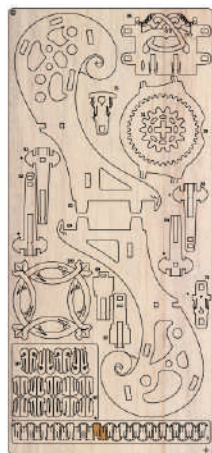
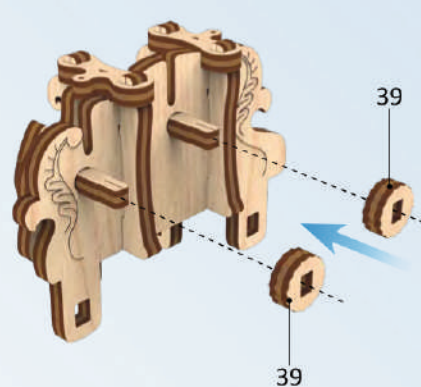

6

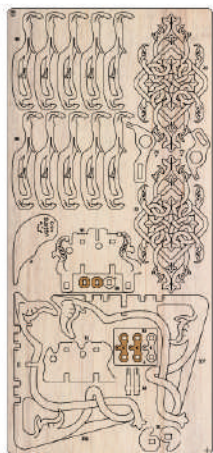

7

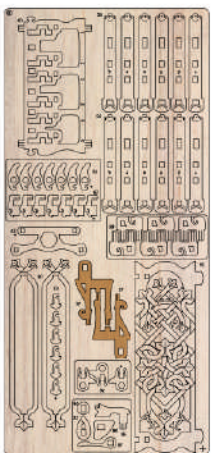

8

4

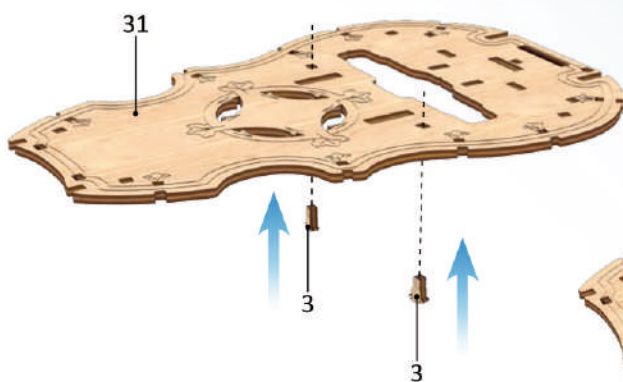

5

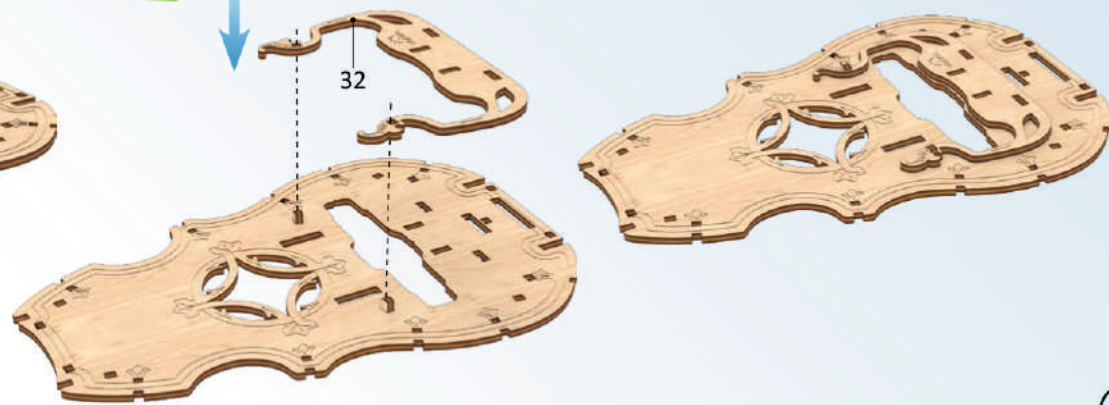

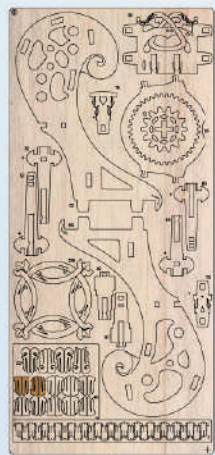

6

1

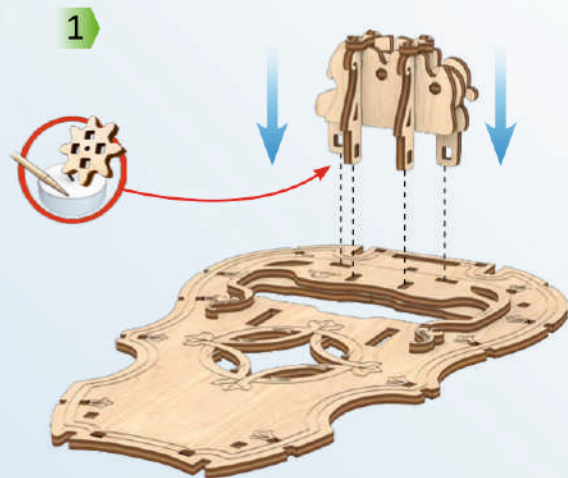

2

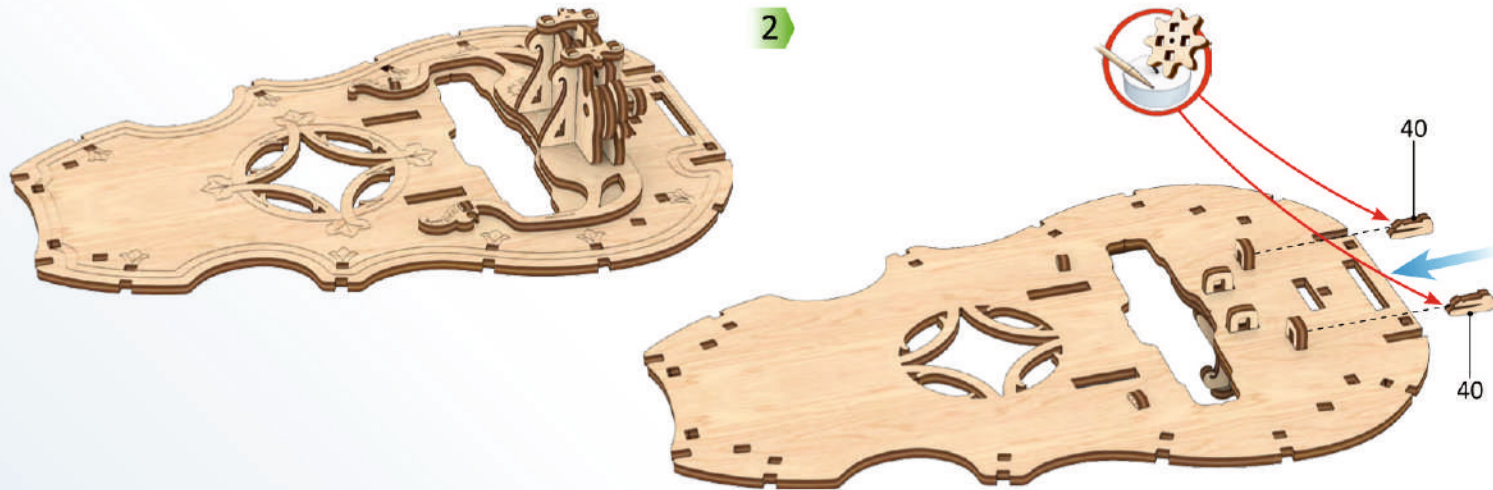

3

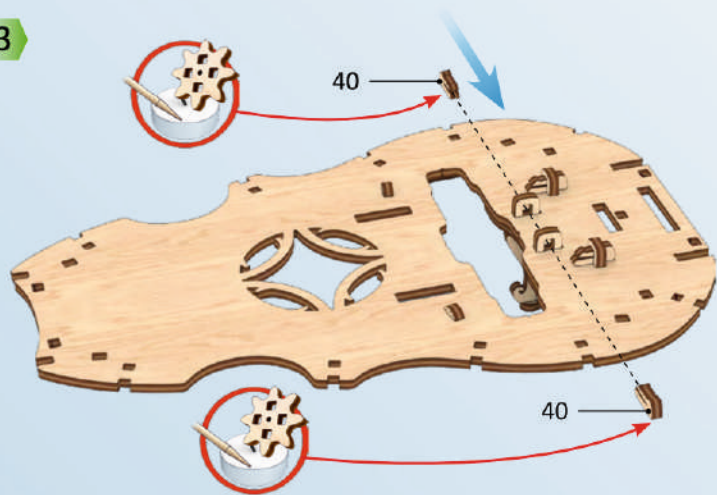

4

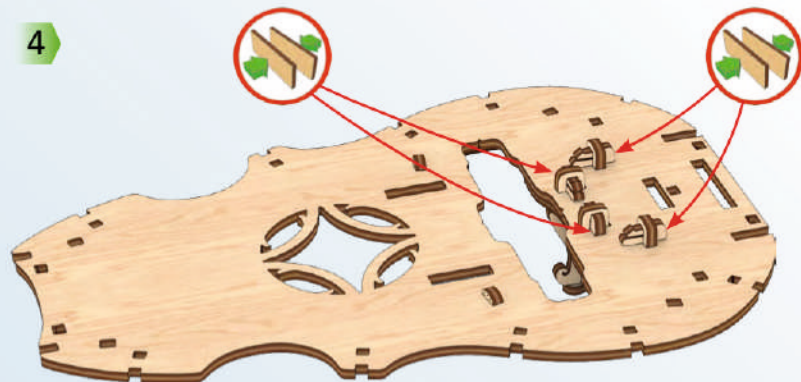

C



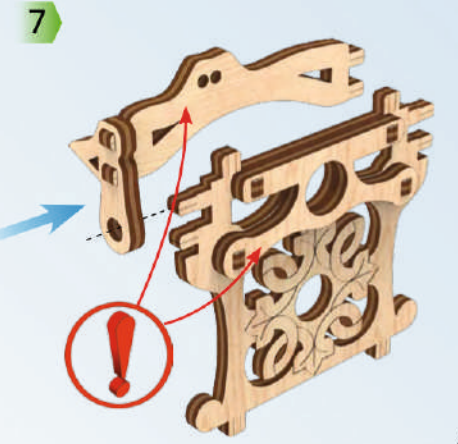
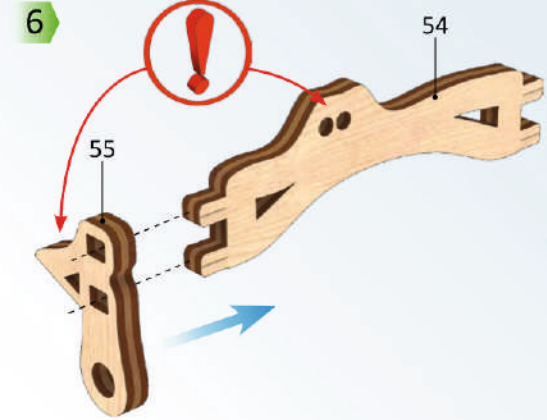
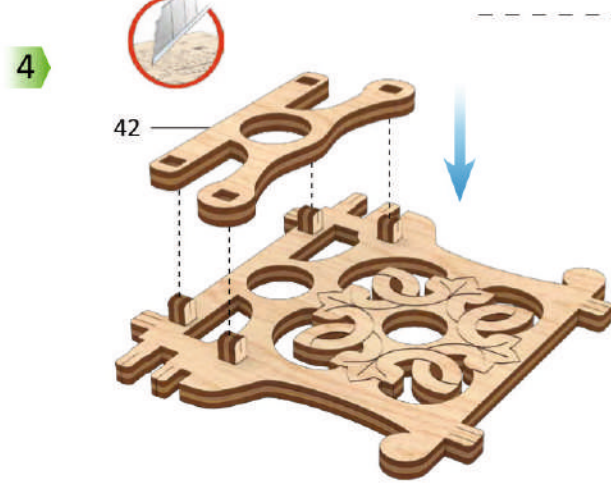
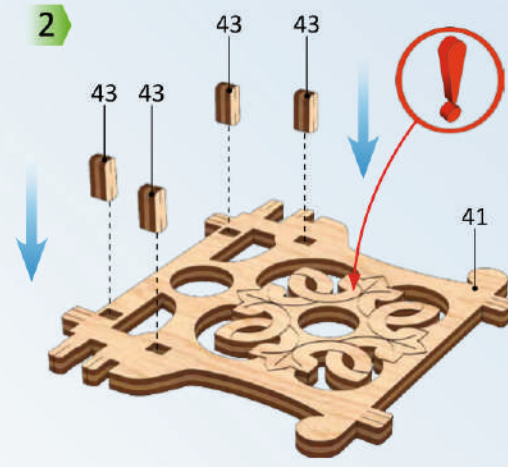
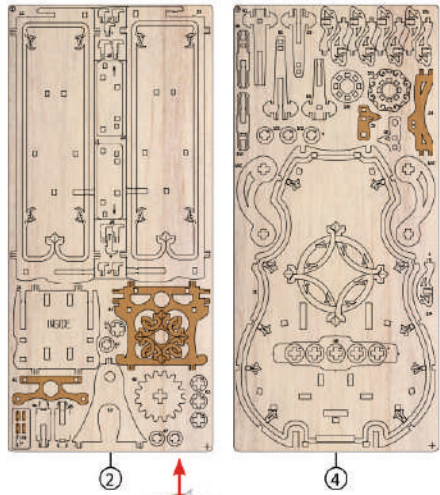

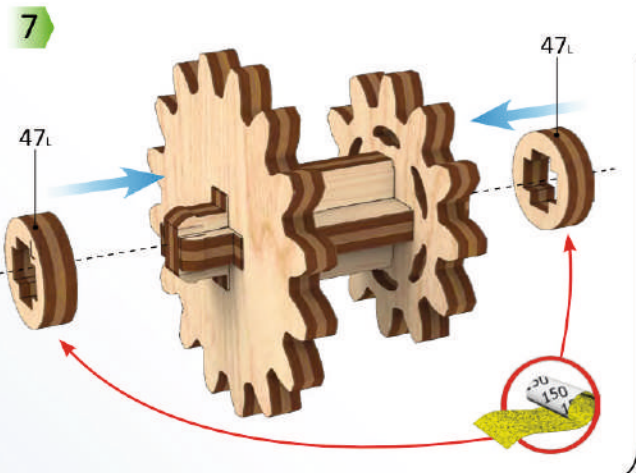
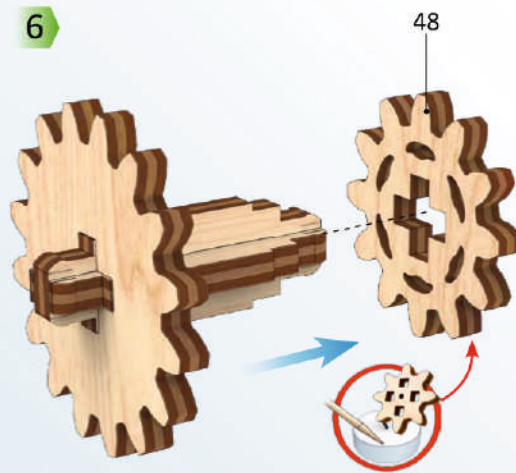
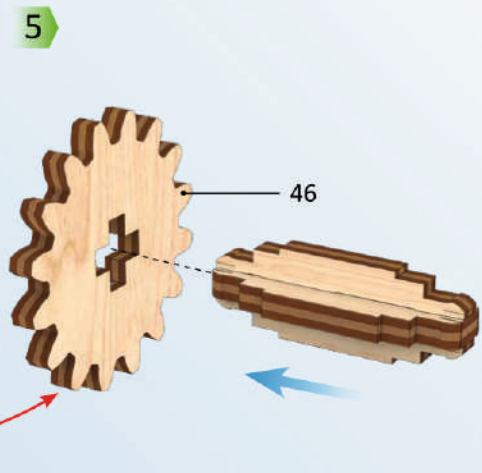
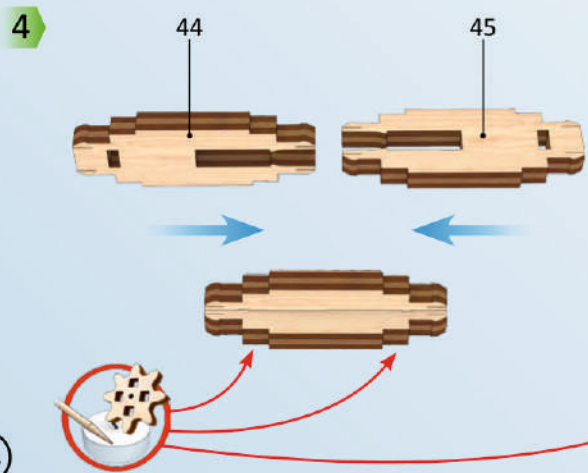
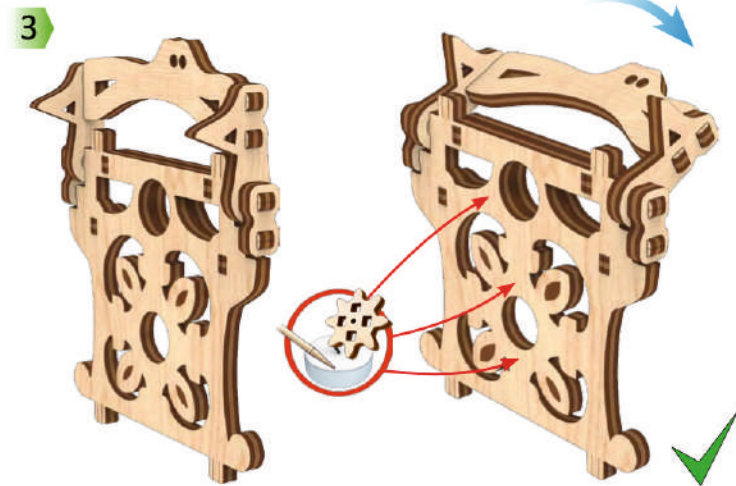
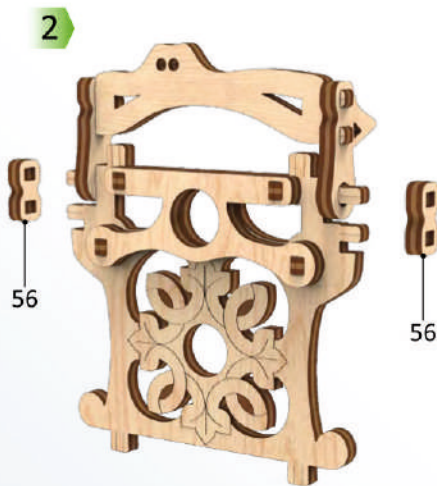
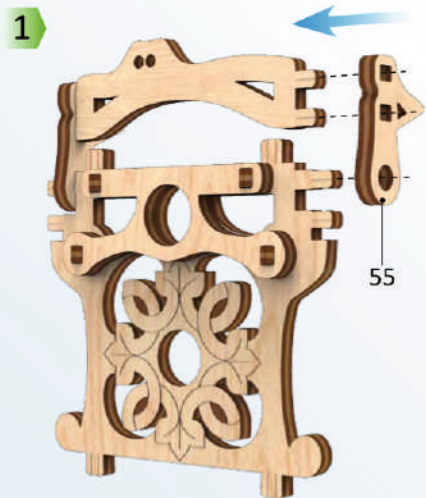
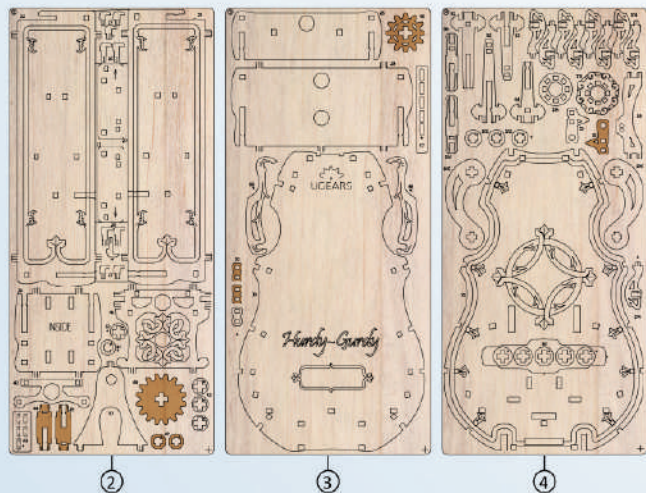

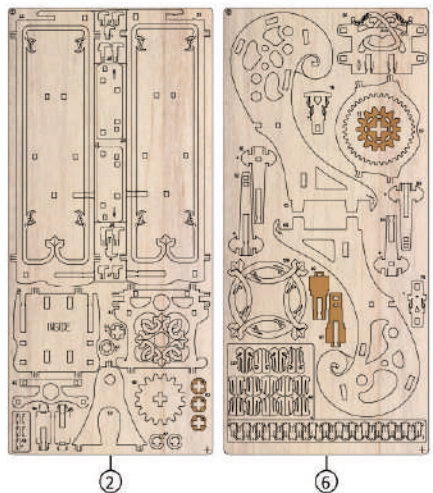

1

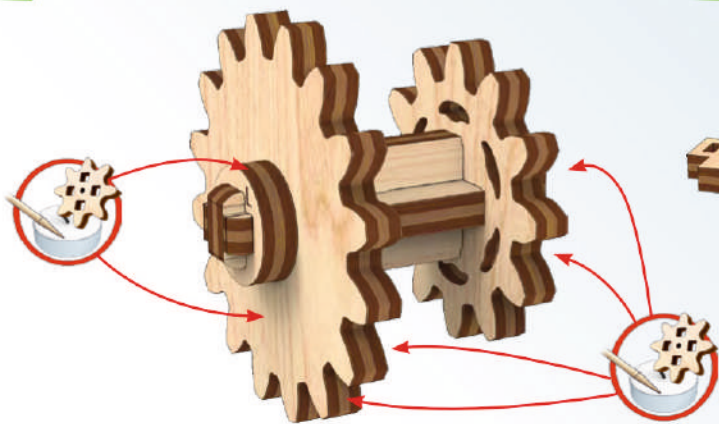

2

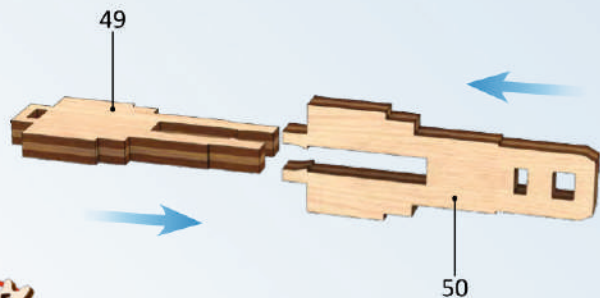

3

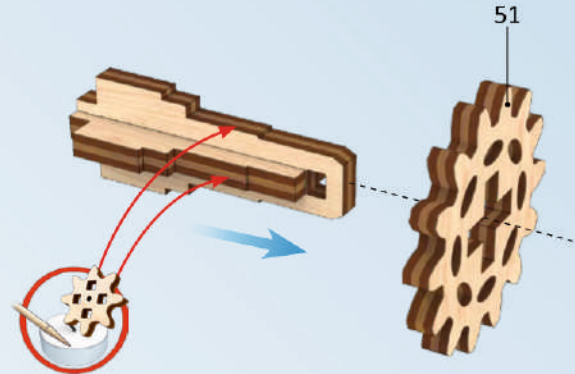

4

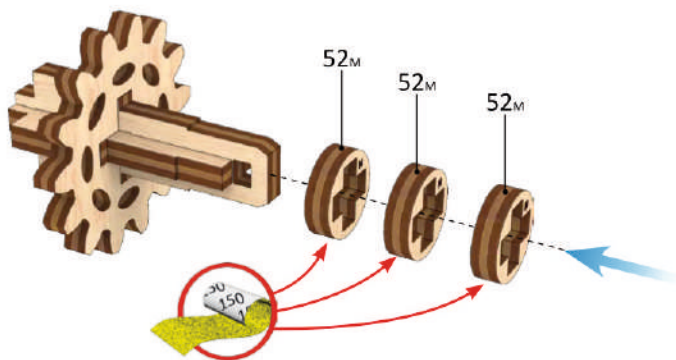

5

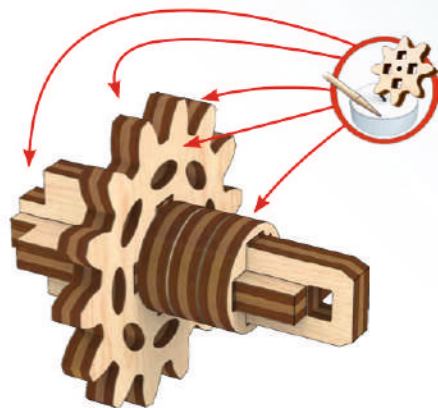

6

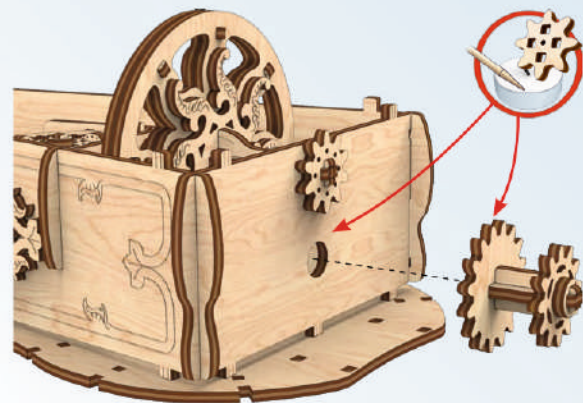

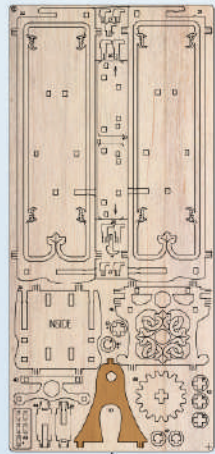

2

1

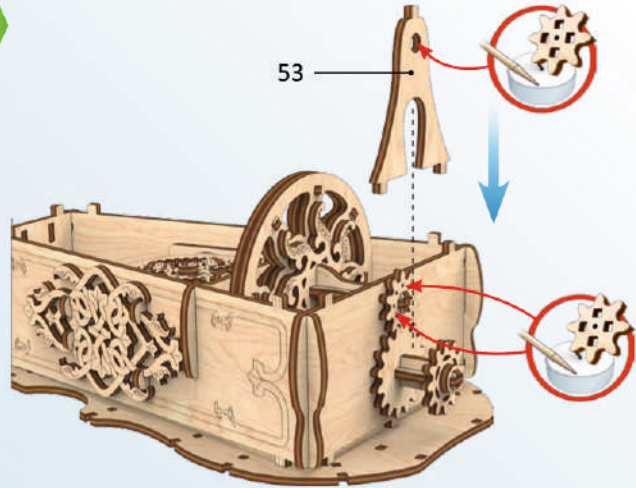

2

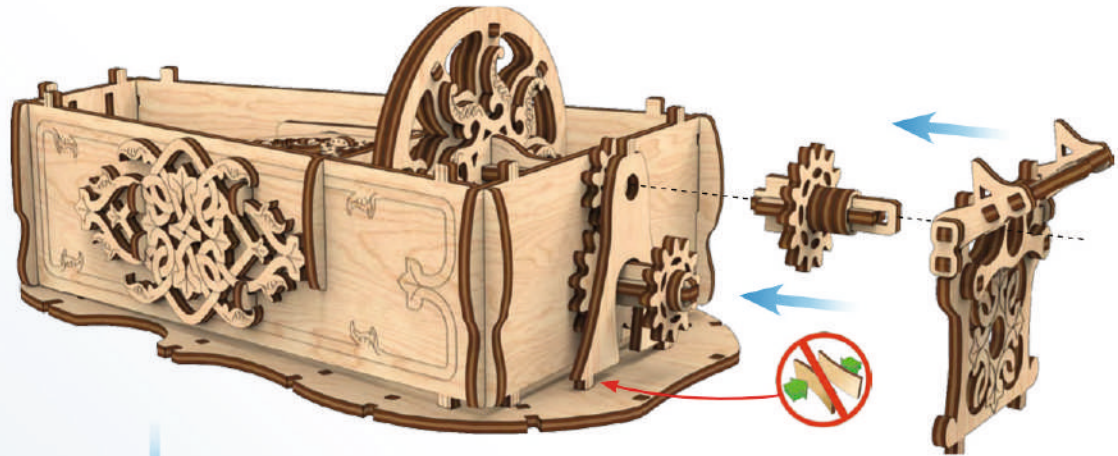

3



4

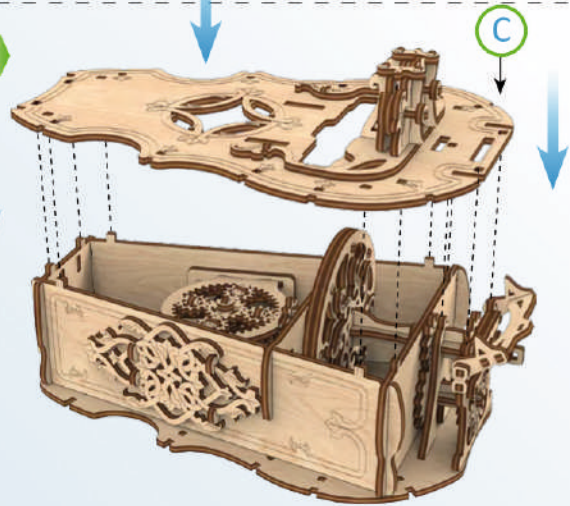

5

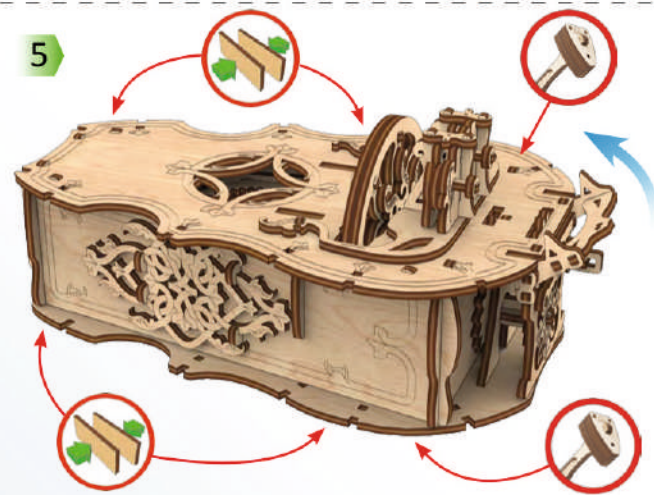



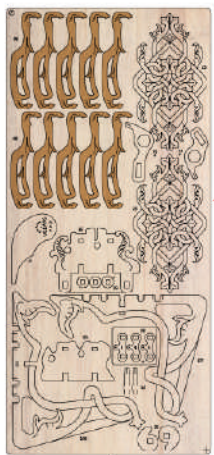

7

1

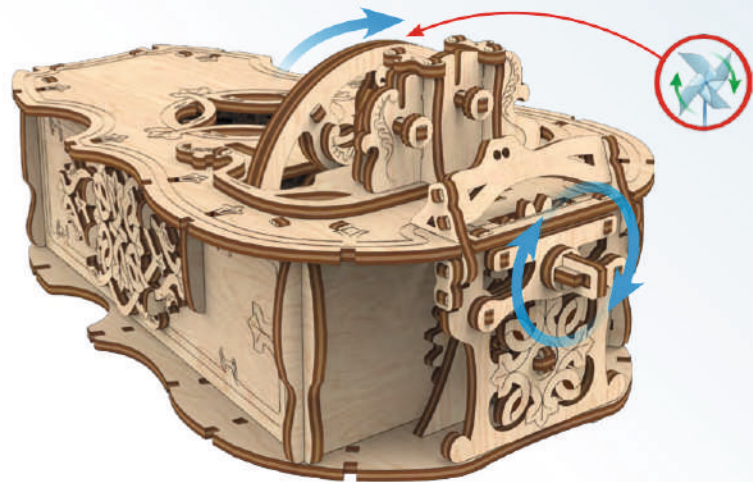

2



3

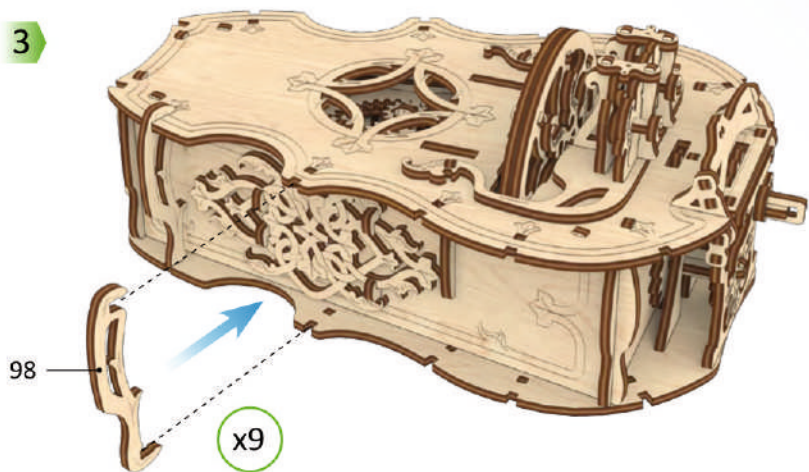

4



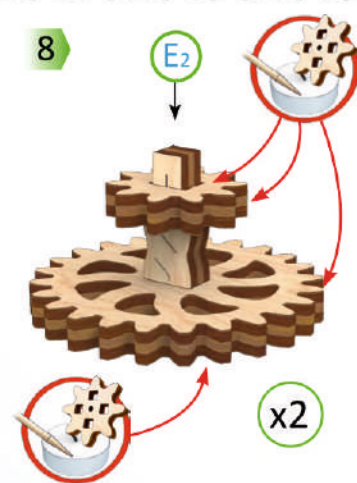
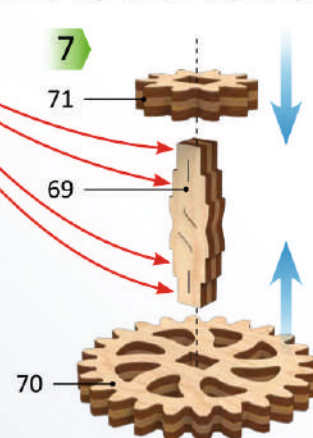
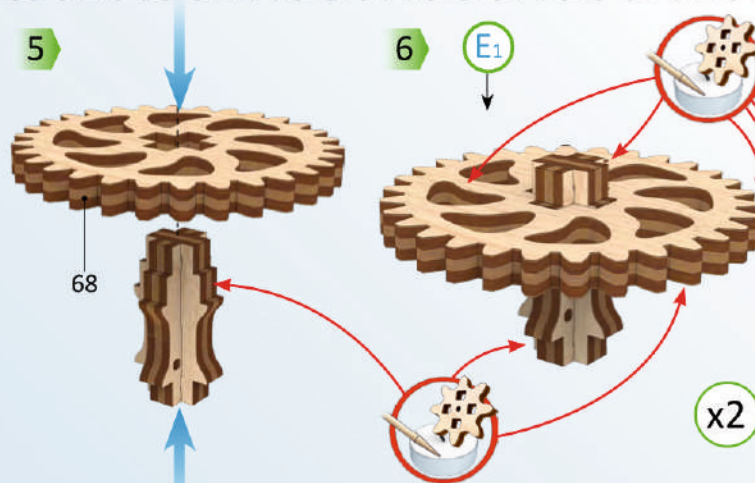
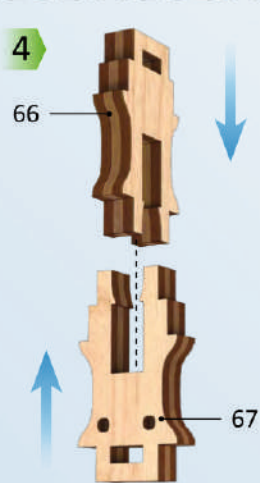
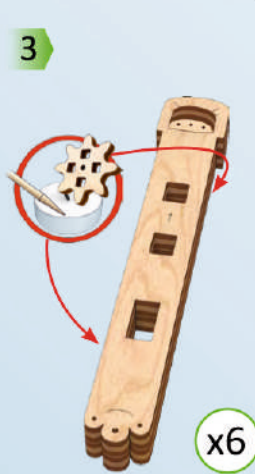
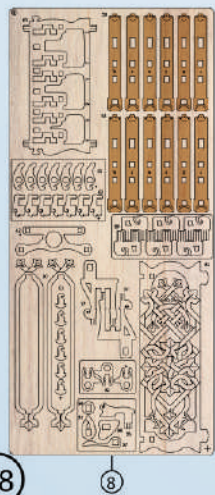
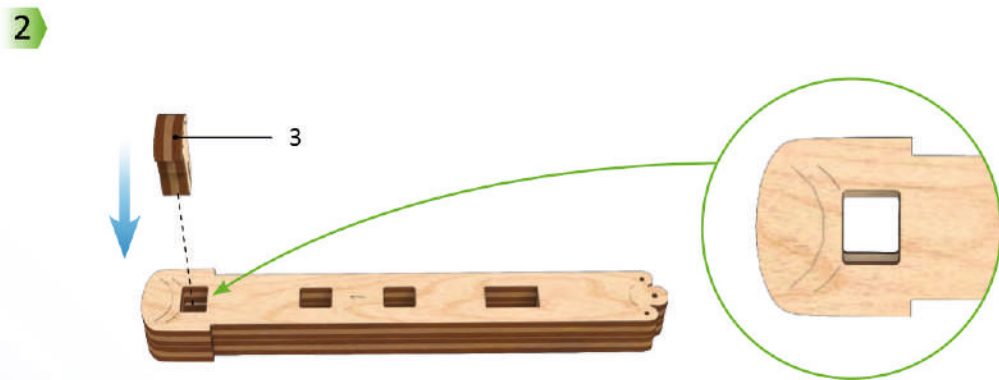
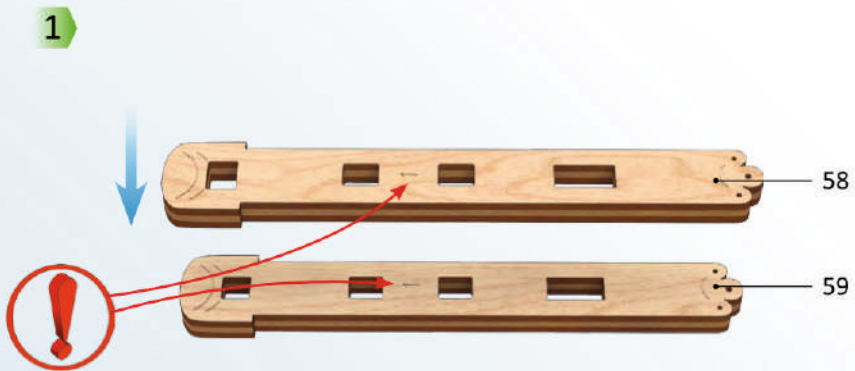
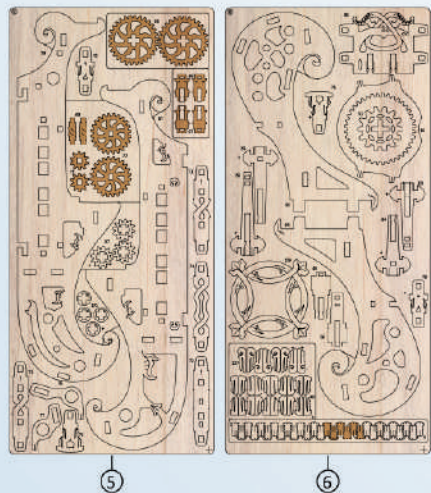



5

6

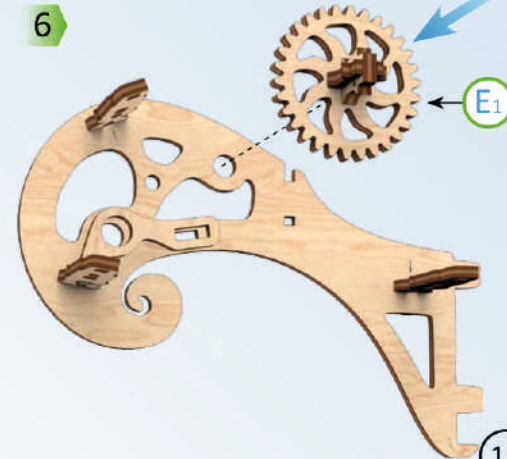
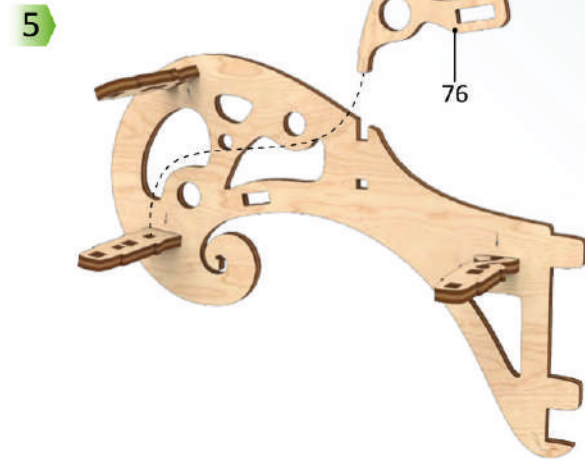
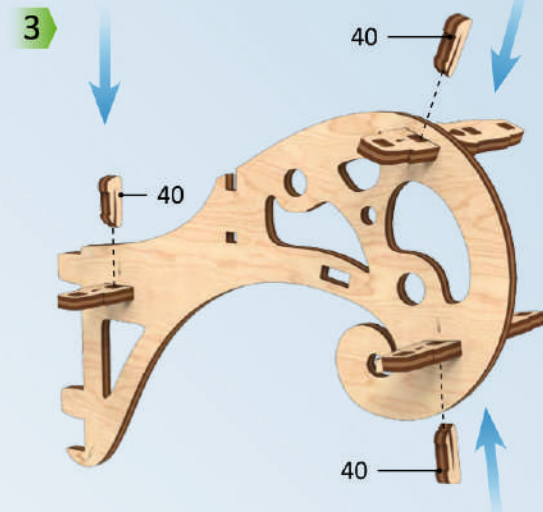
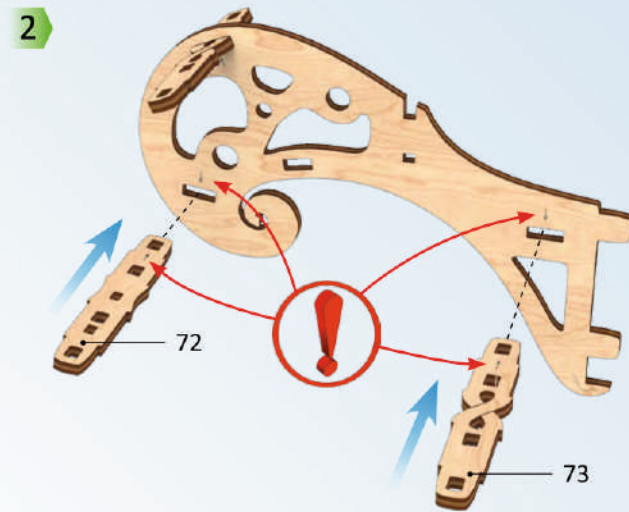
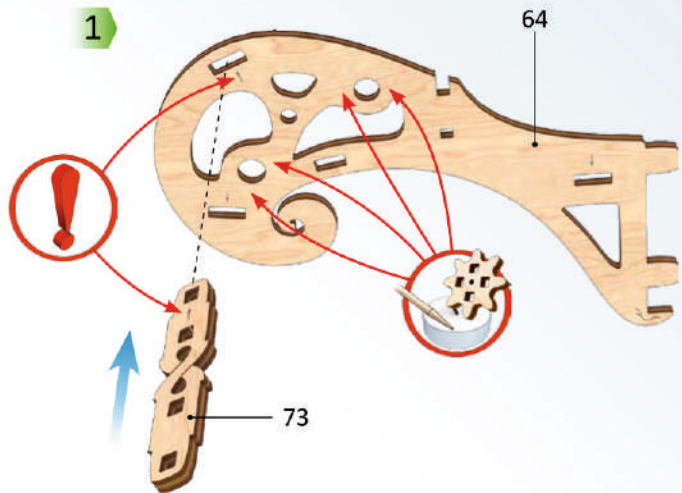

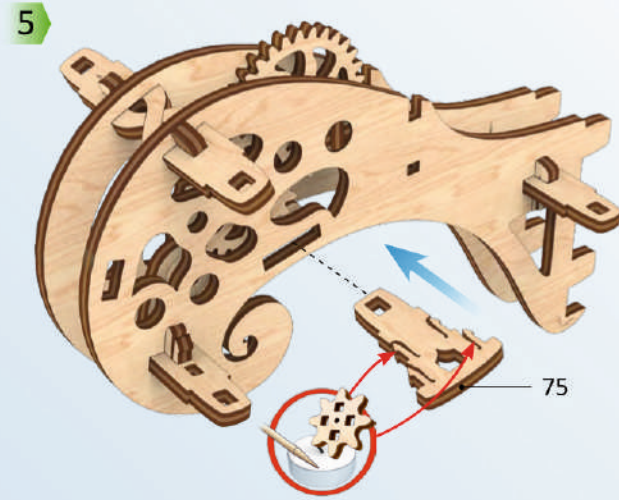
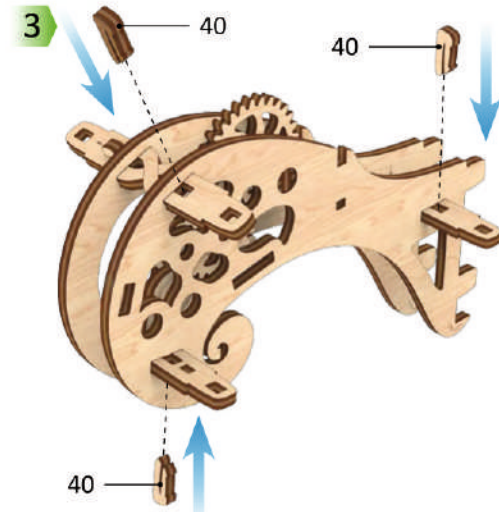
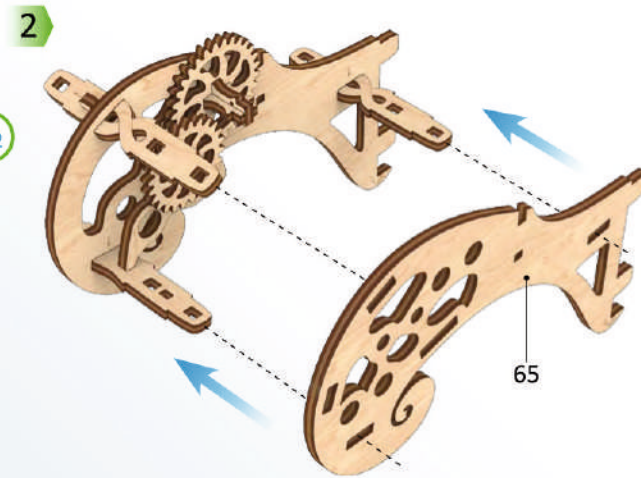
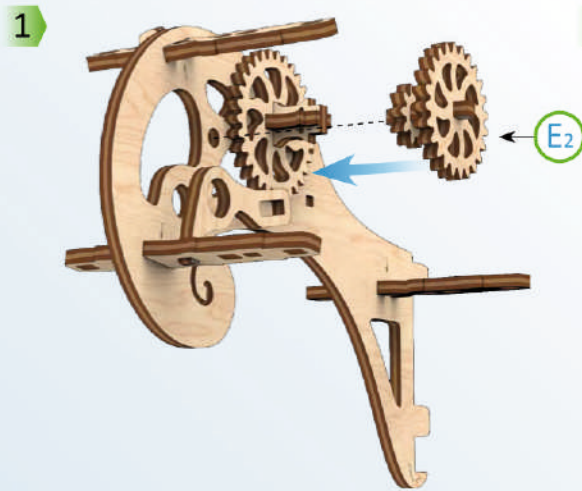

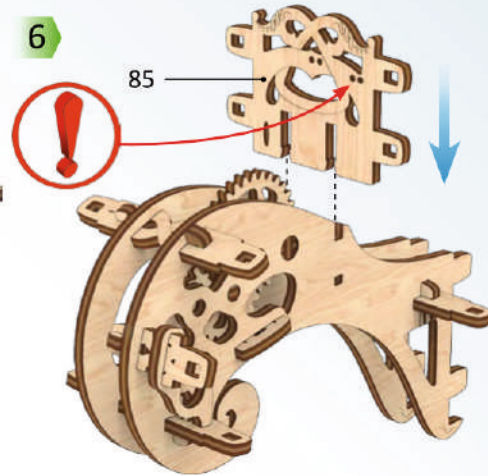
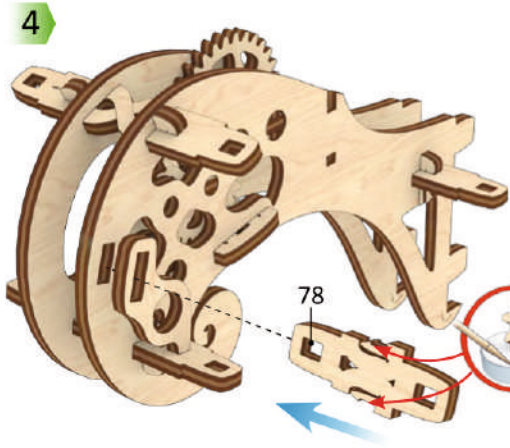
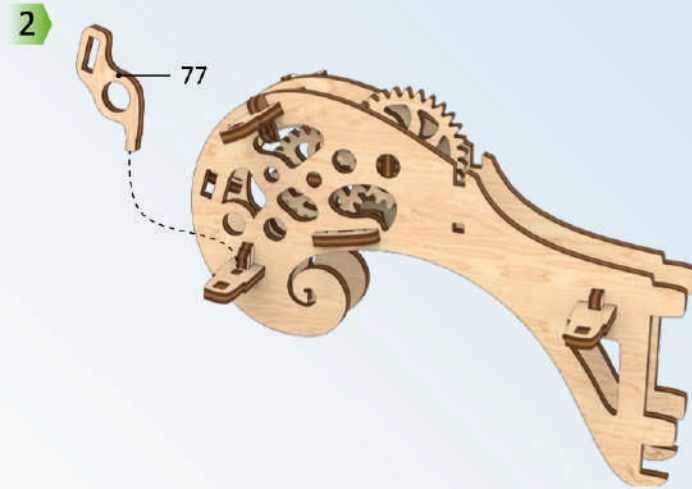
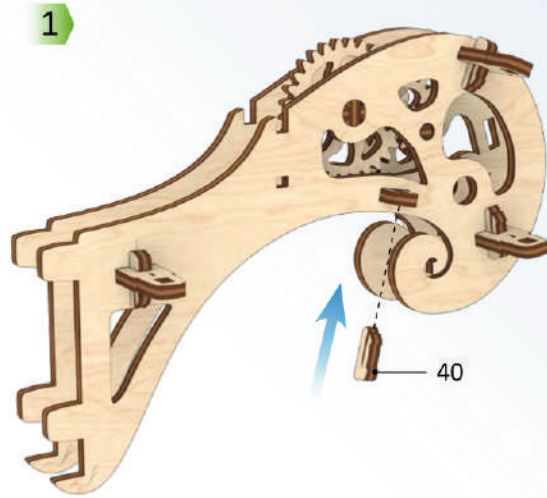
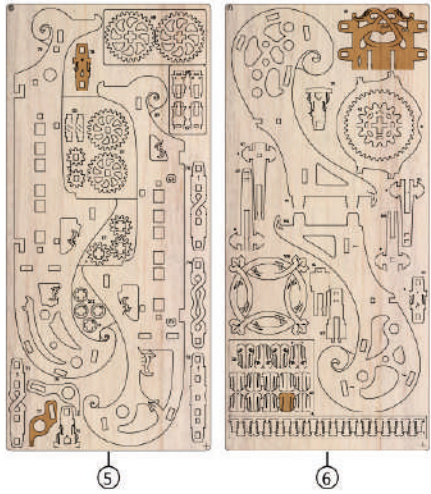

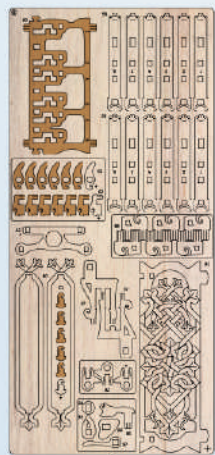

8

1

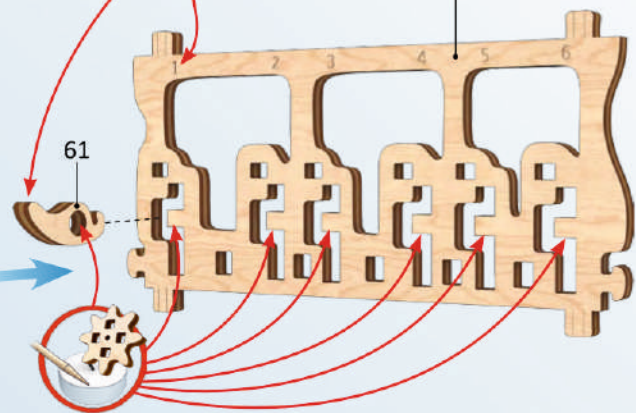

60

2

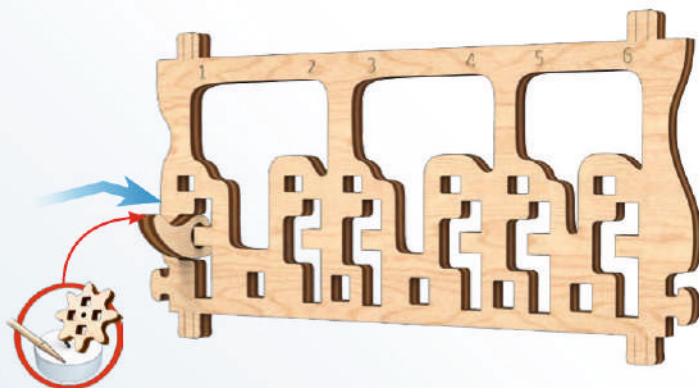

3

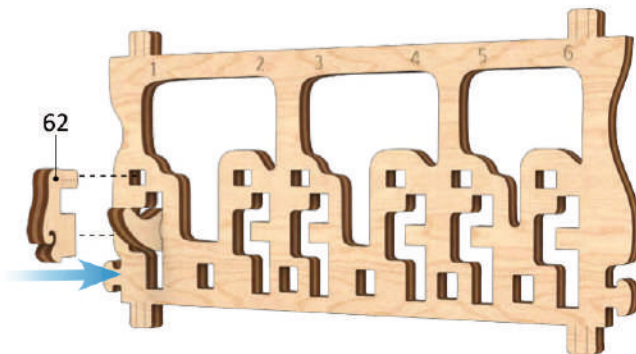

62

4

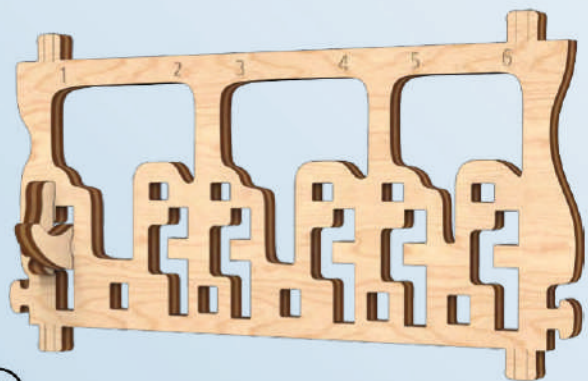

5

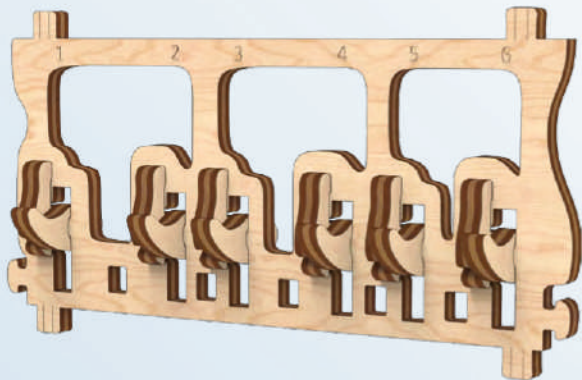

x6

6

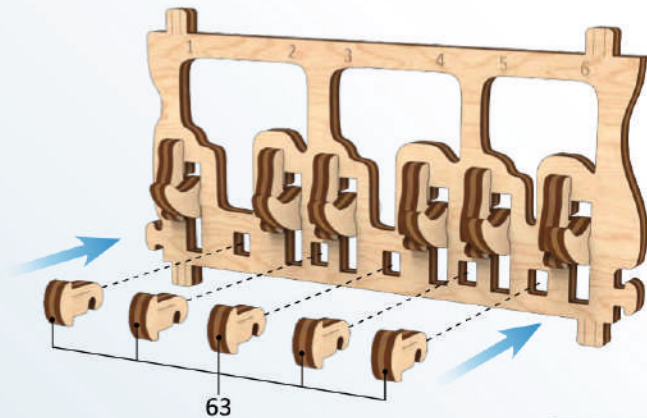

63



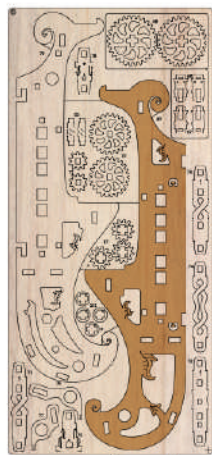

5

1



2

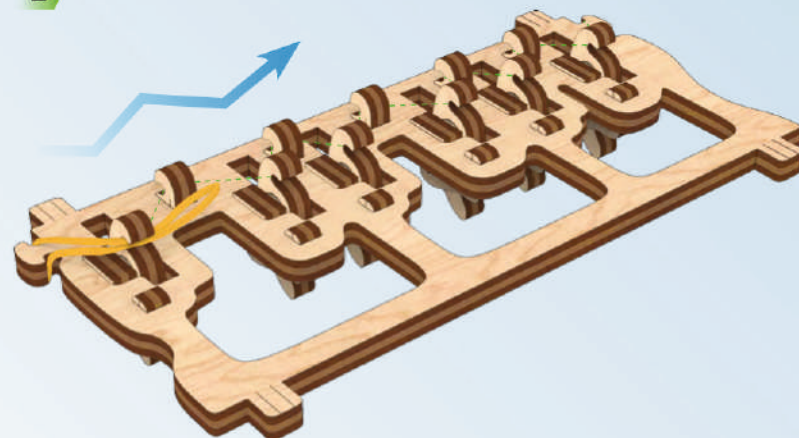

3

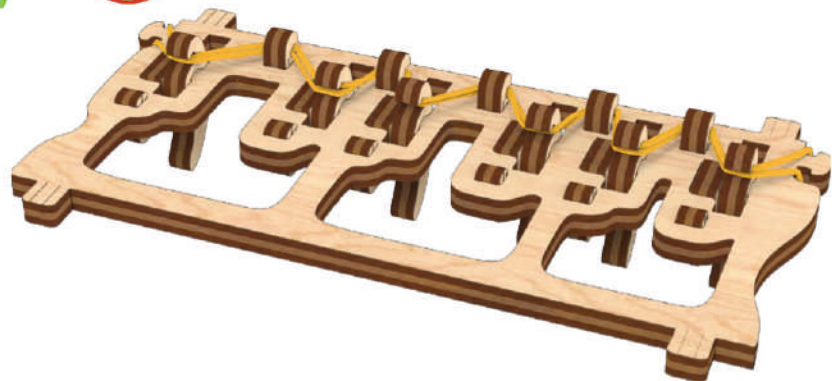

4

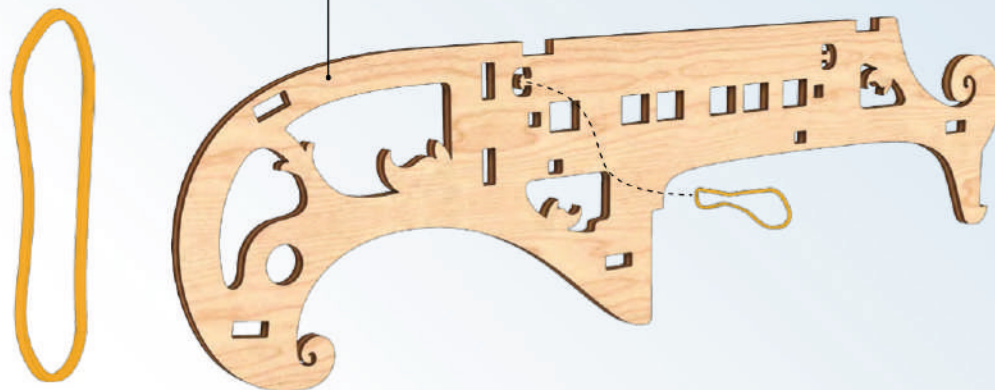

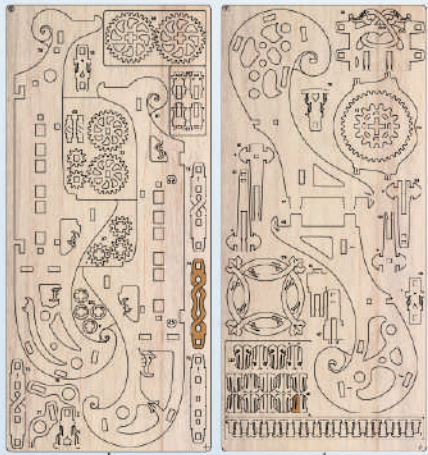

5

6

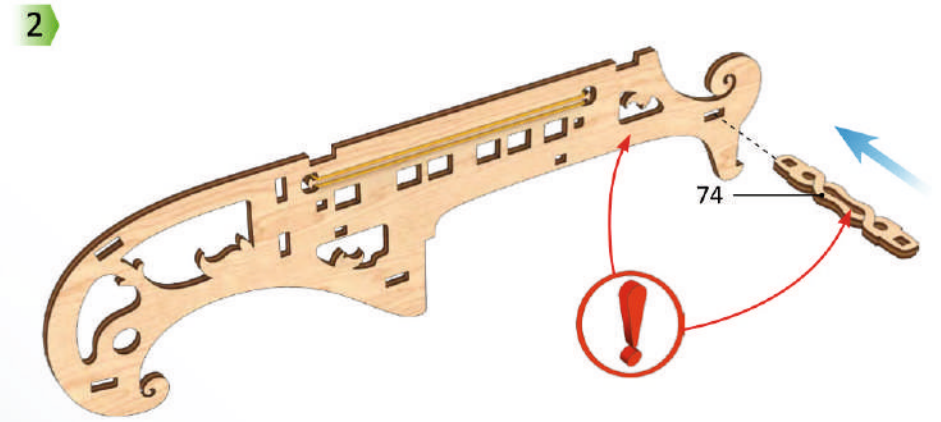
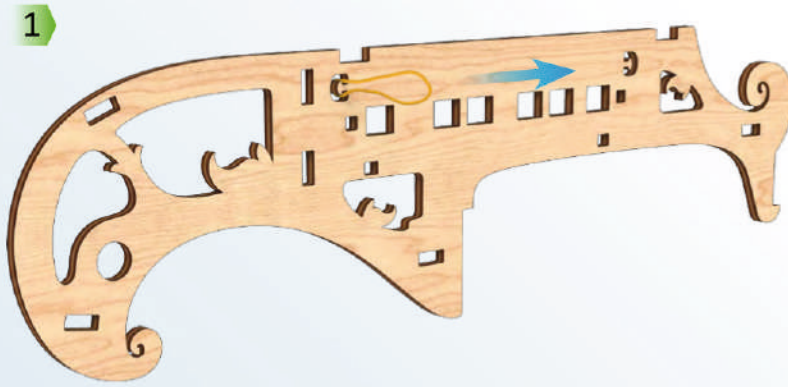

74

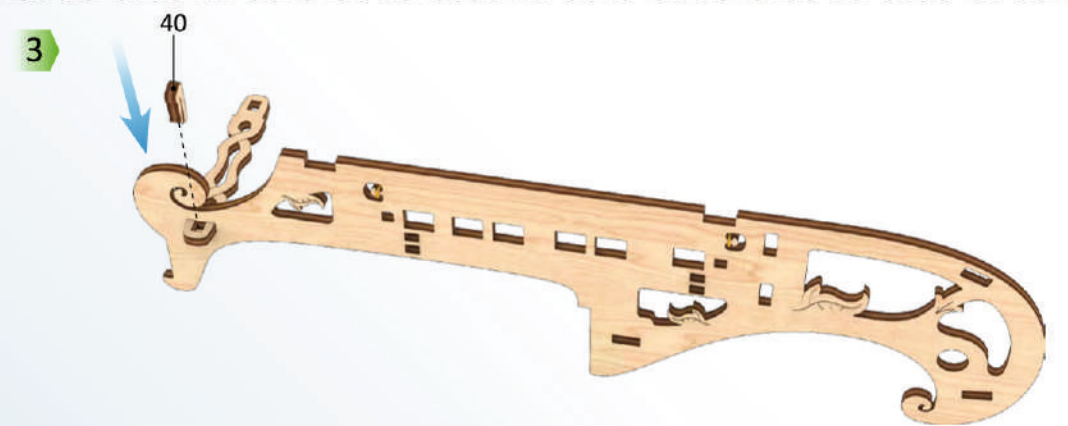

40





6

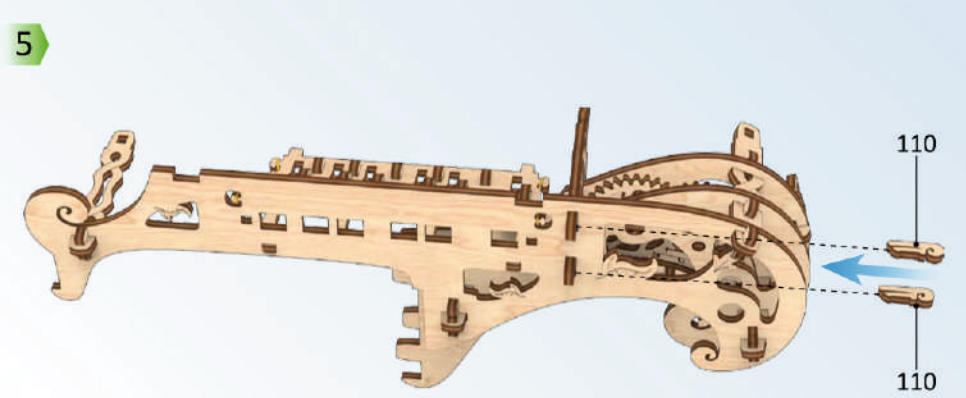
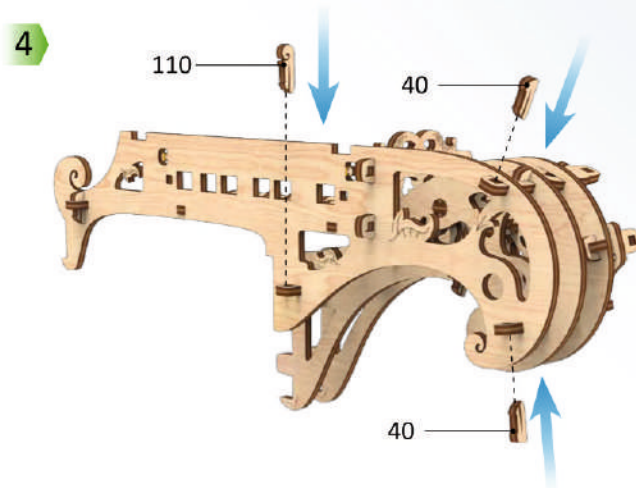
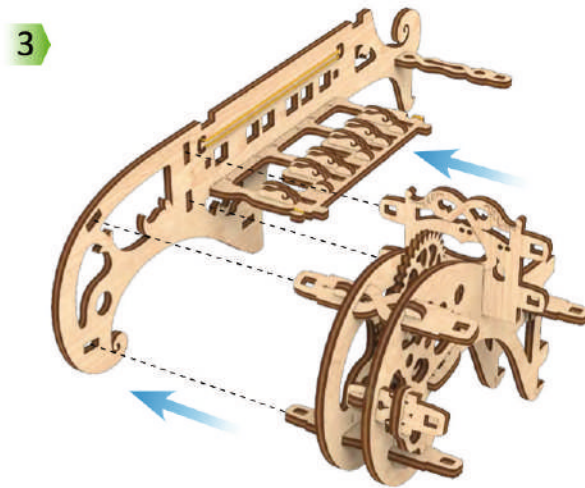
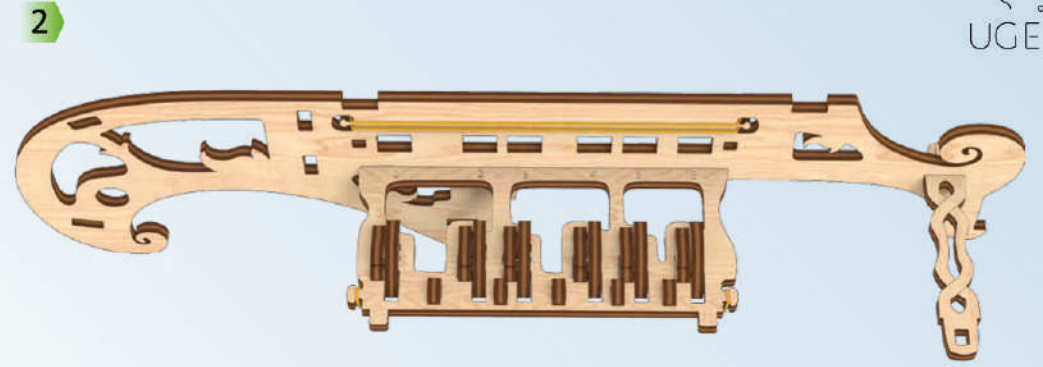
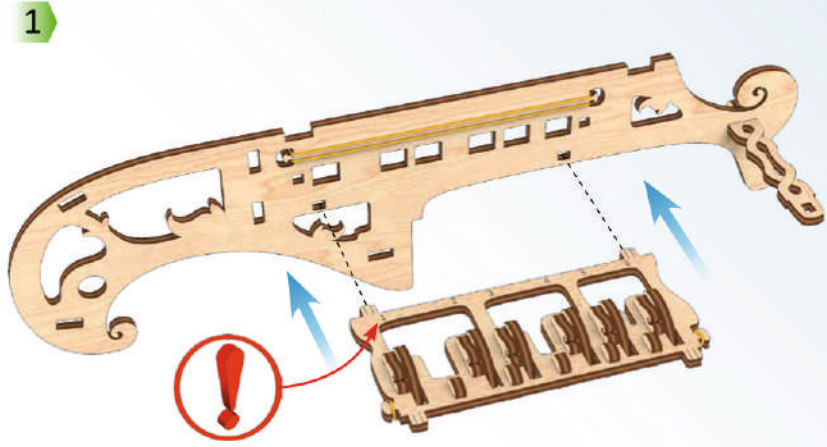

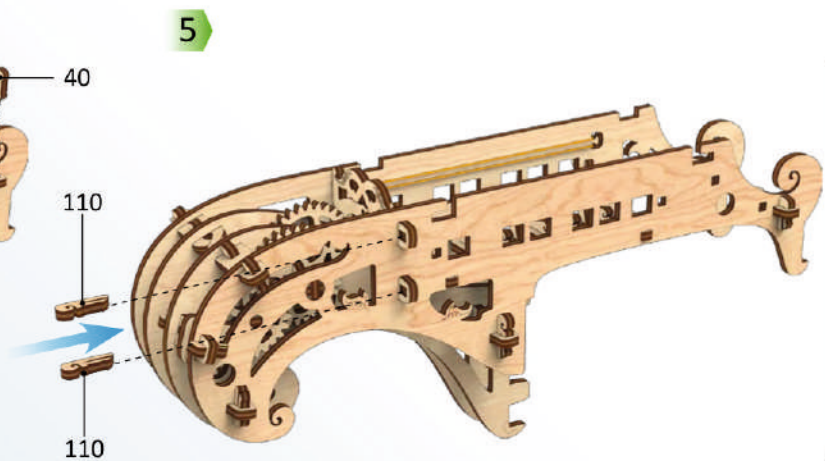
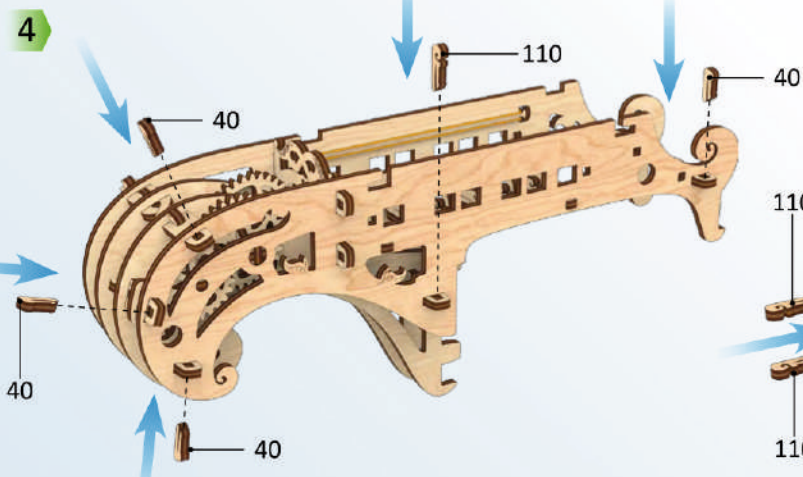
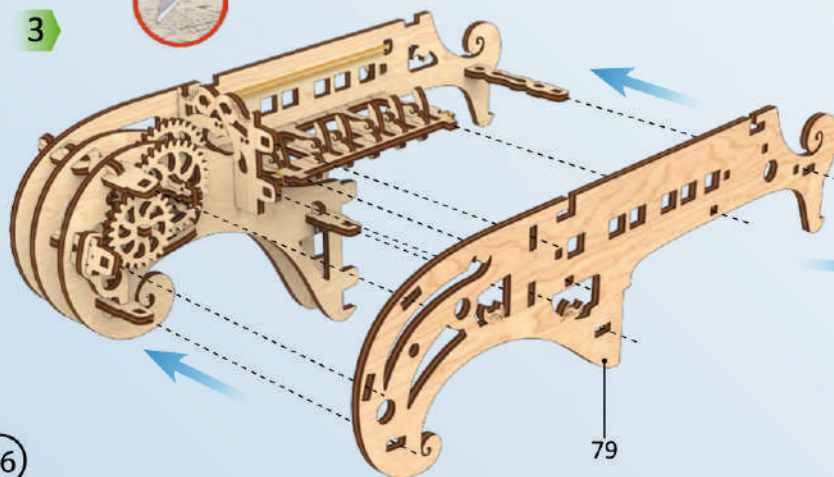
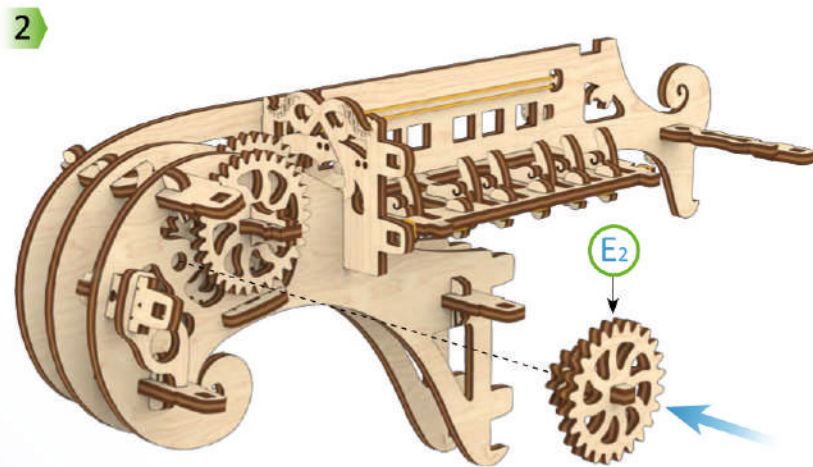
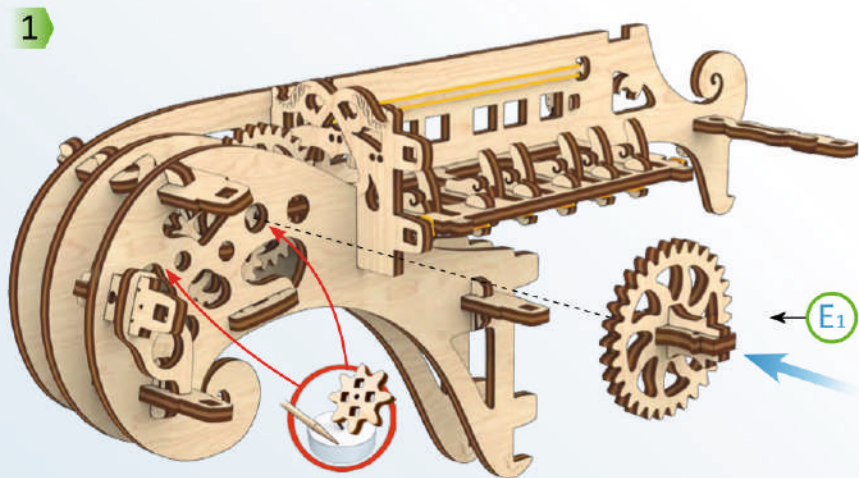
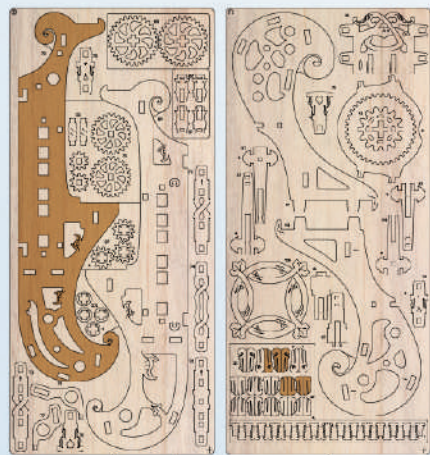

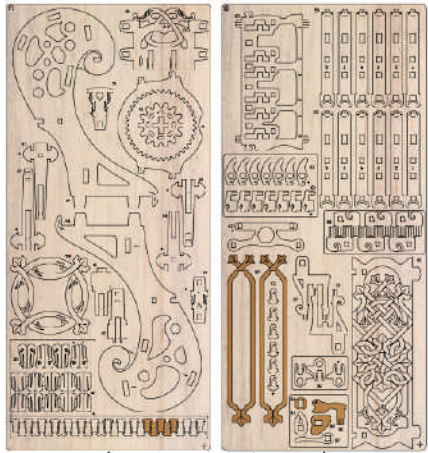

6

8

1

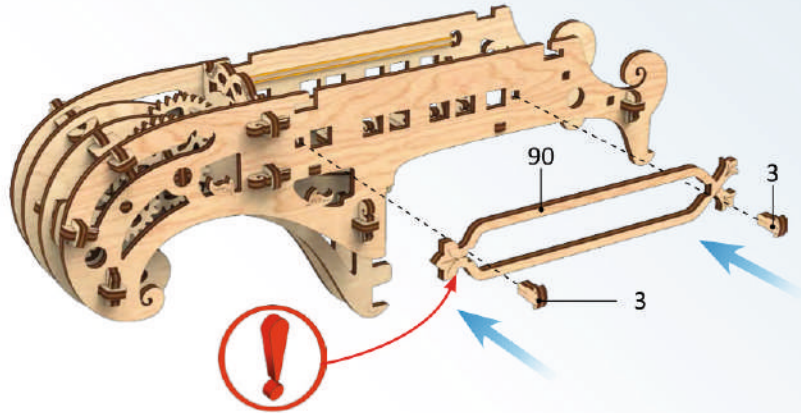

90

3

3

2



3

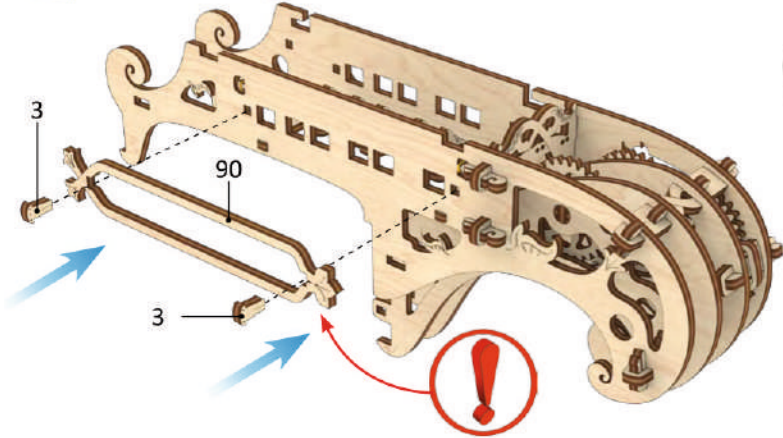

3

90

3



4

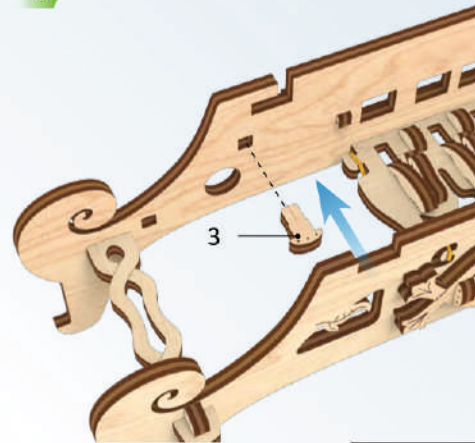

3

5

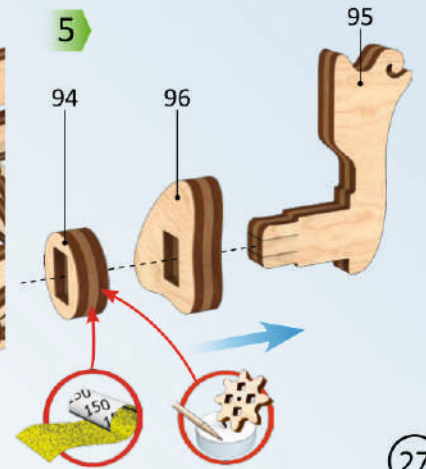

94

96

95



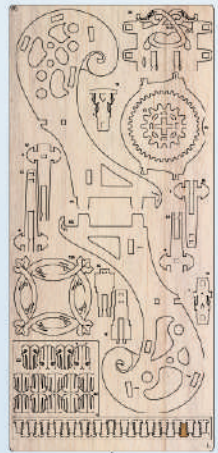

6

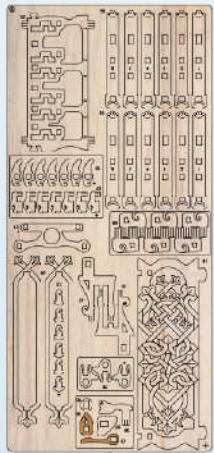

8

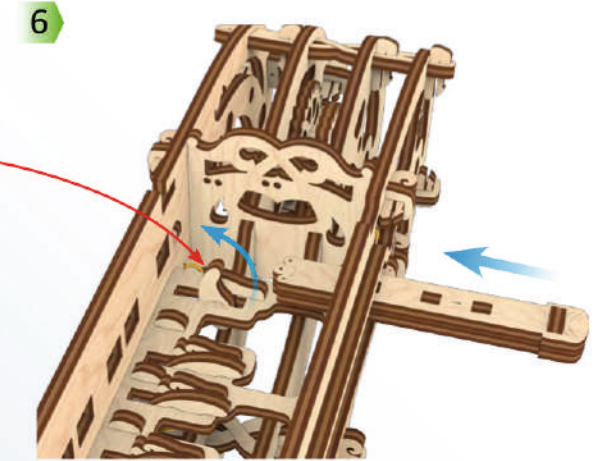
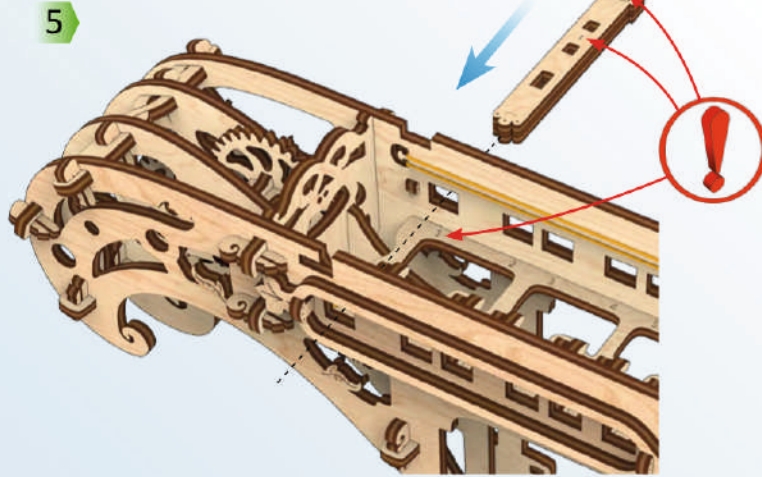
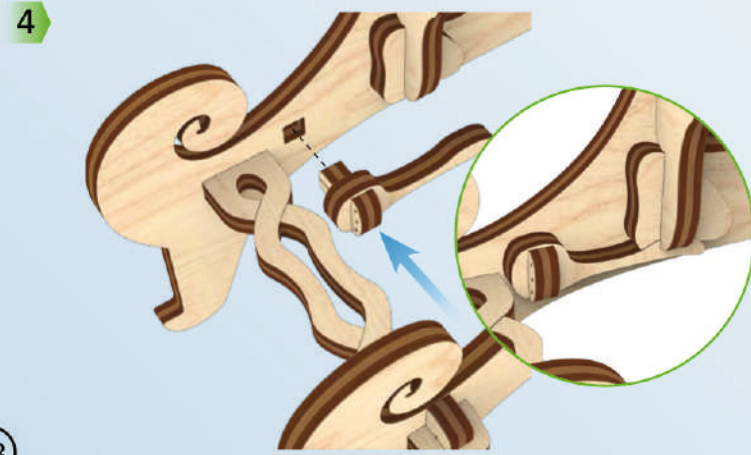
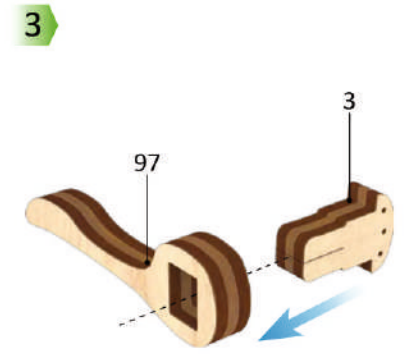
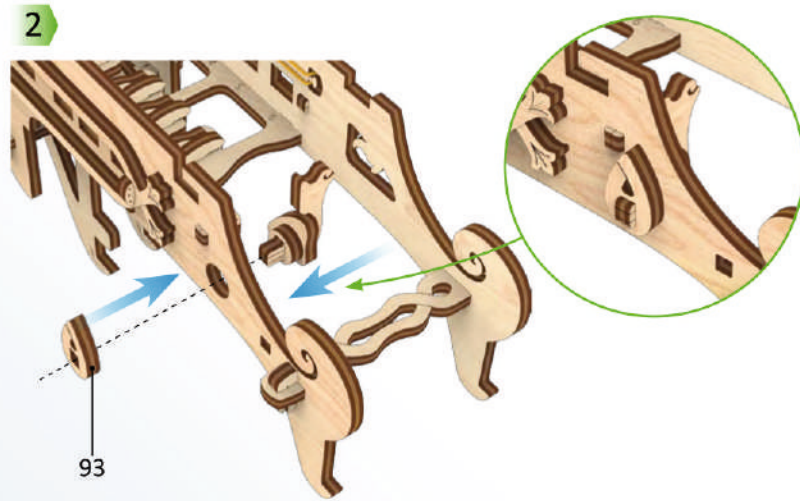
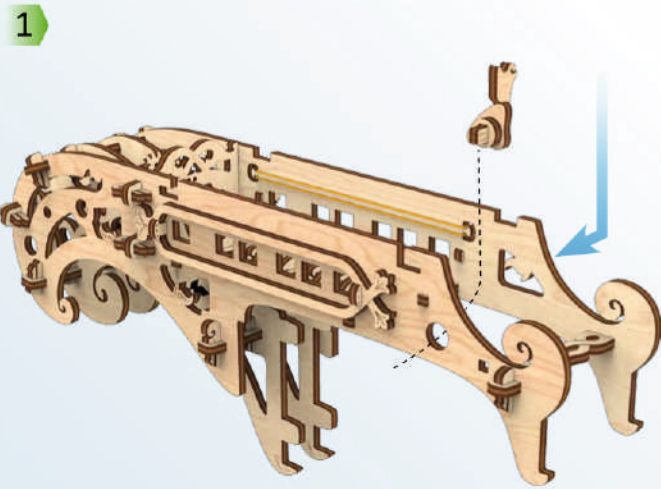

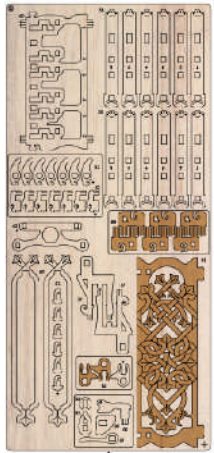

8

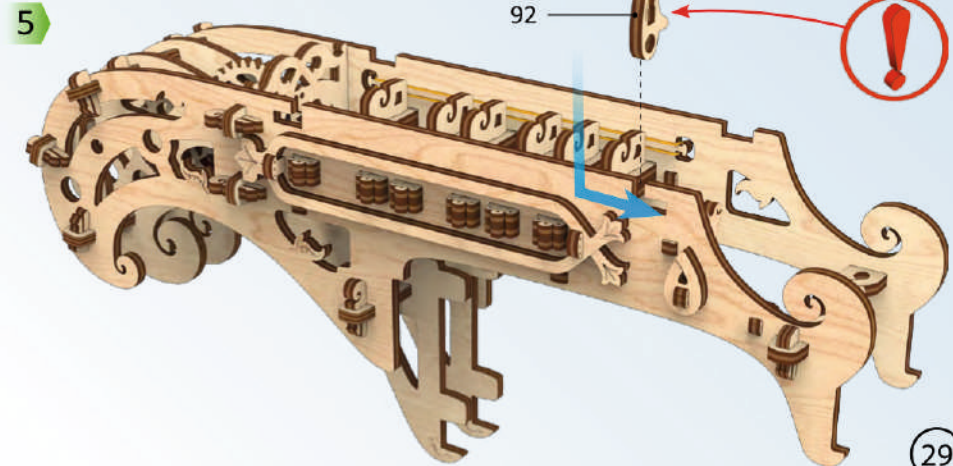
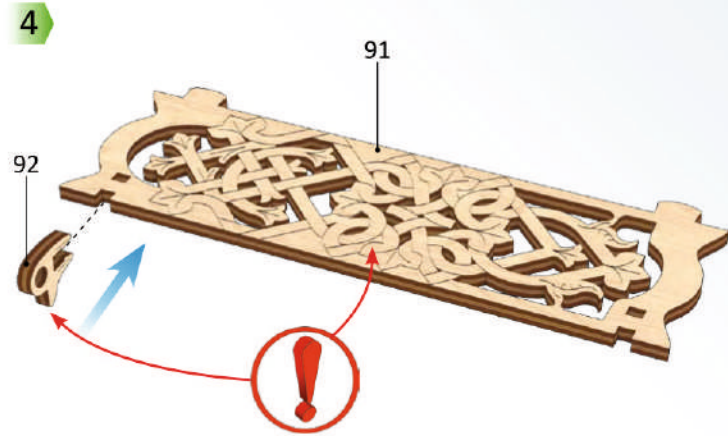
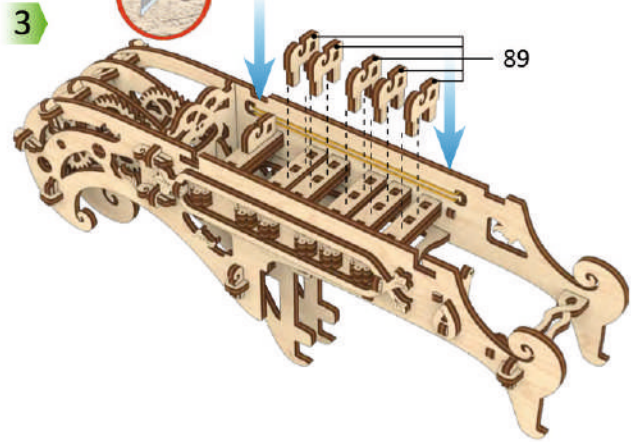
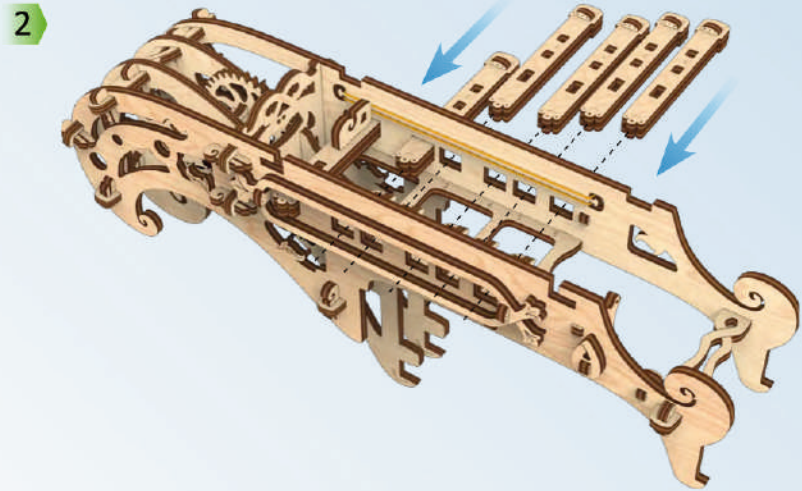
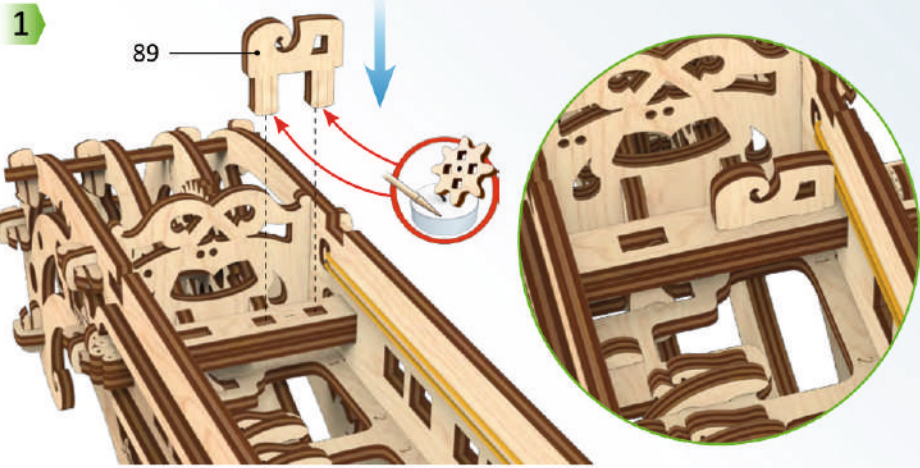



4

1

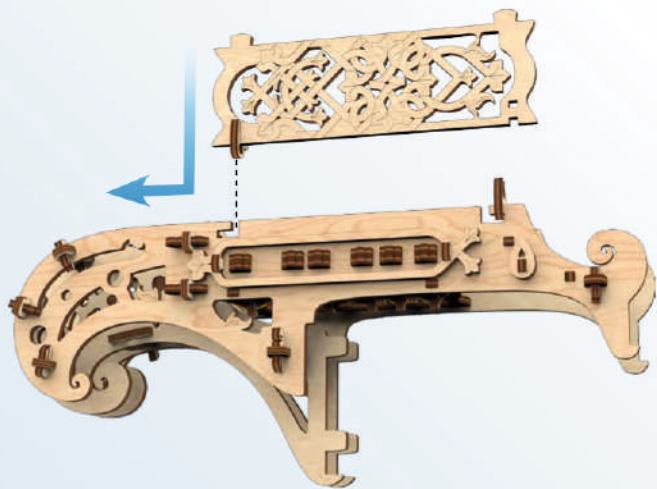

2

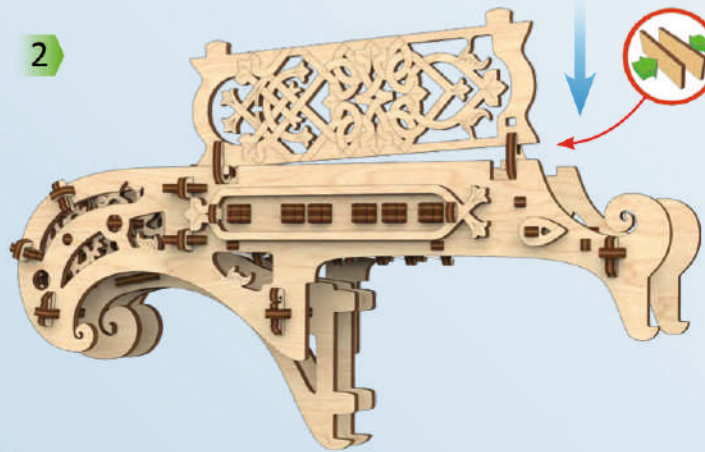

3

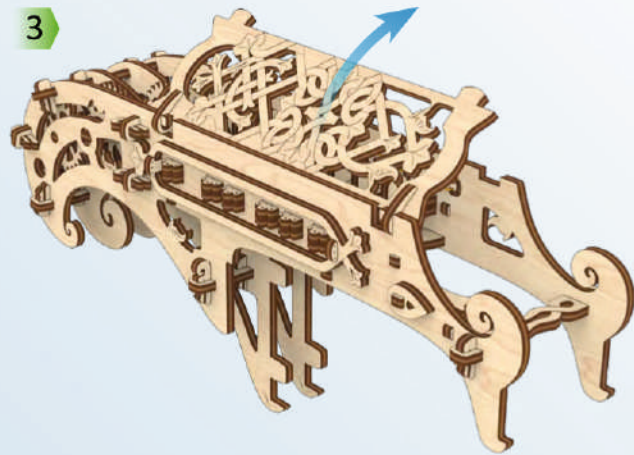

1

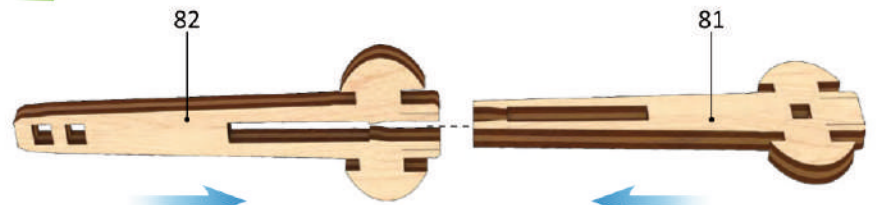

2

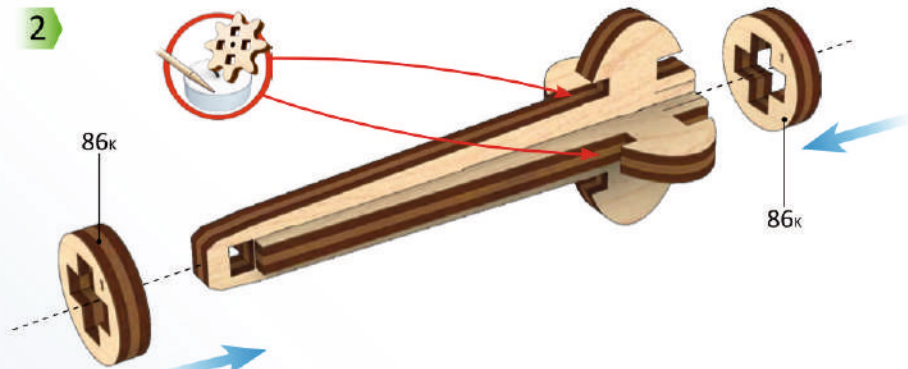

3





4



5

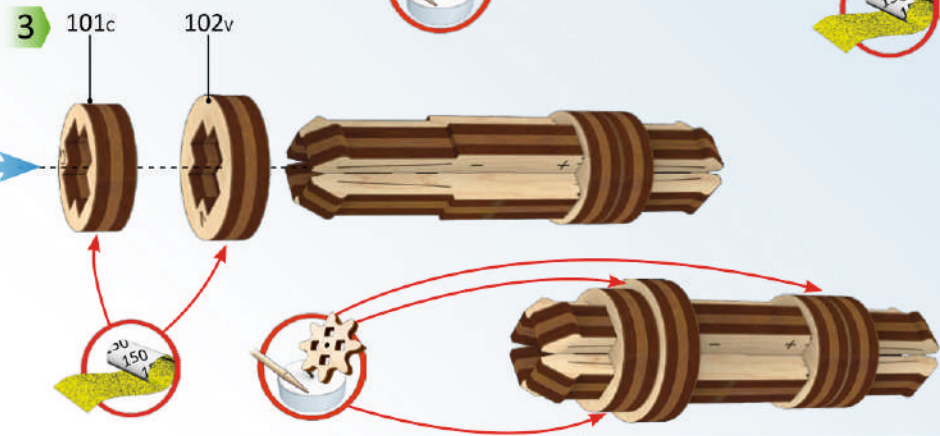
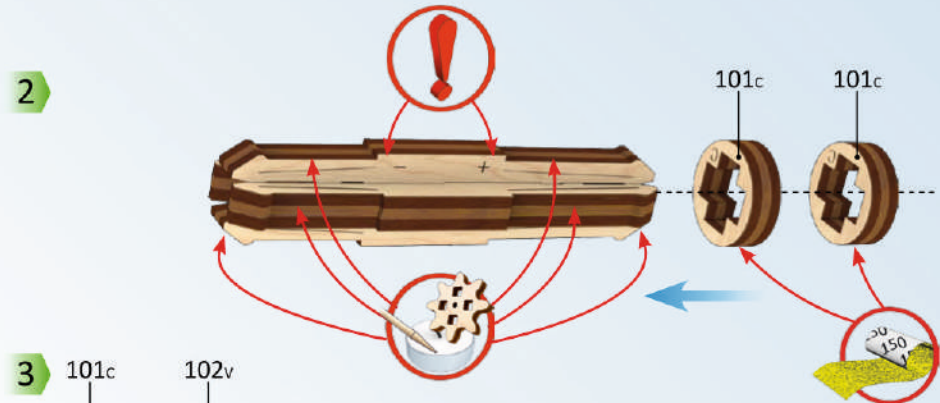
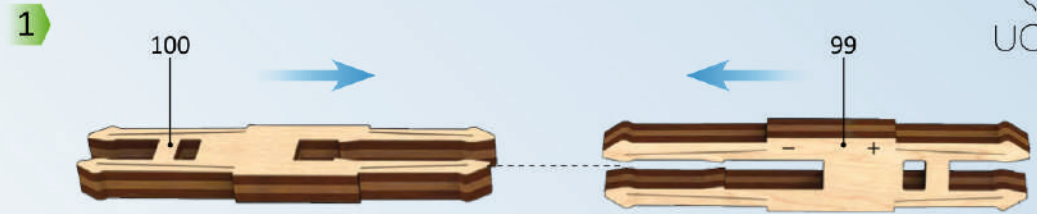
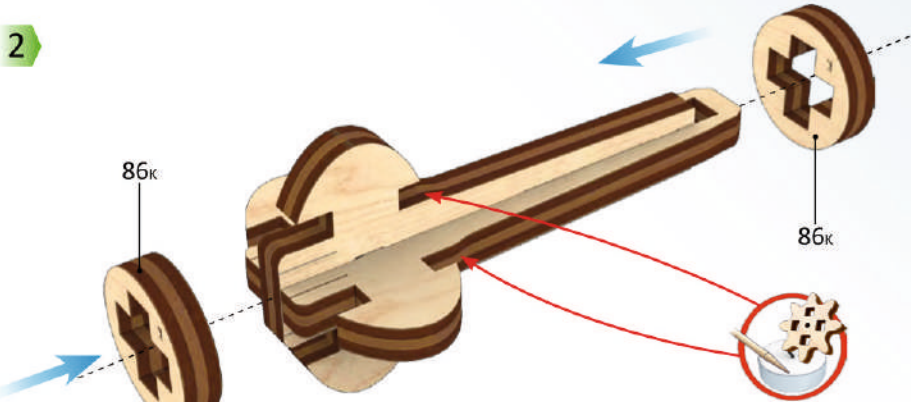
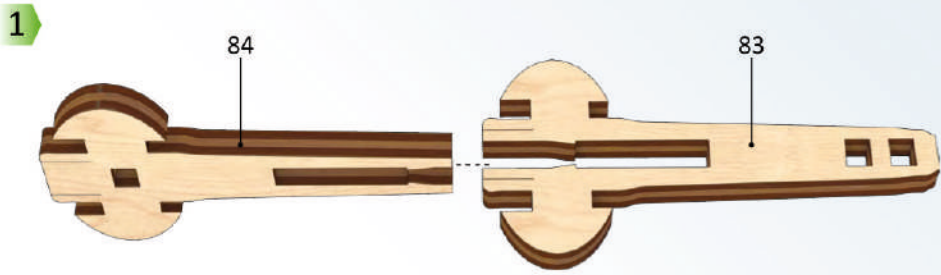

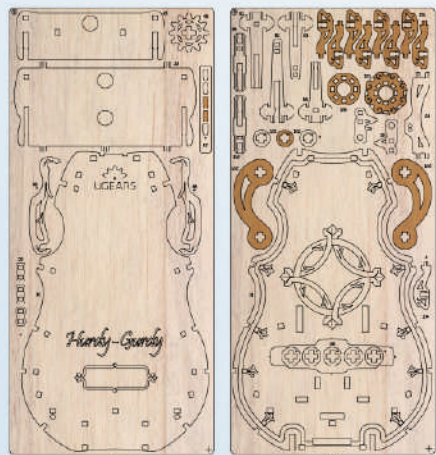

3

4

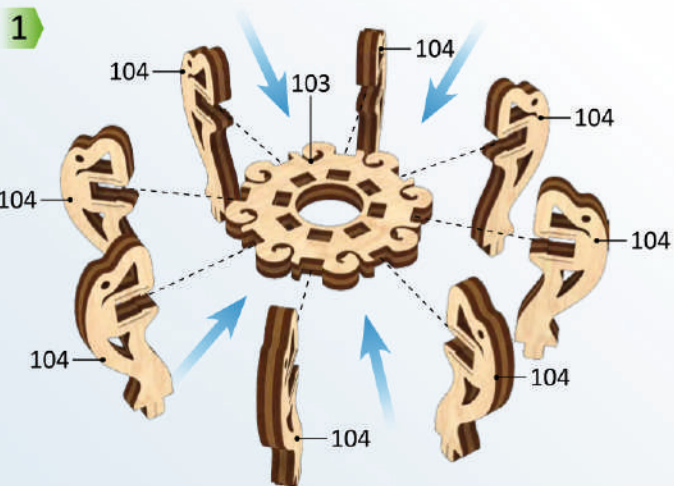

2

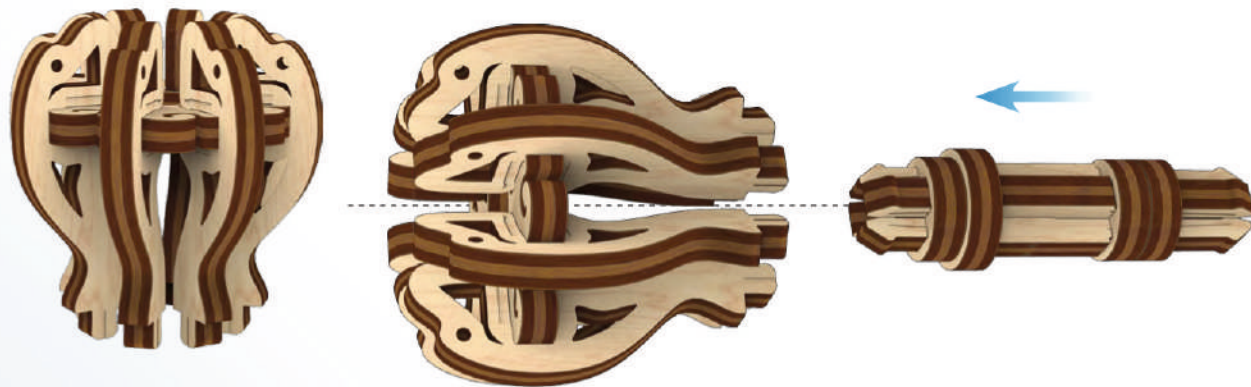

3

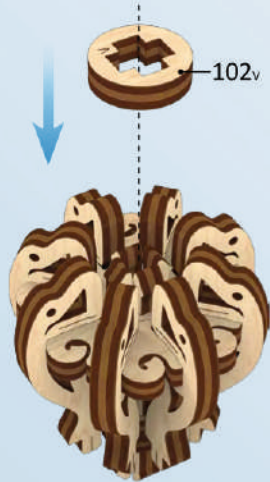

4

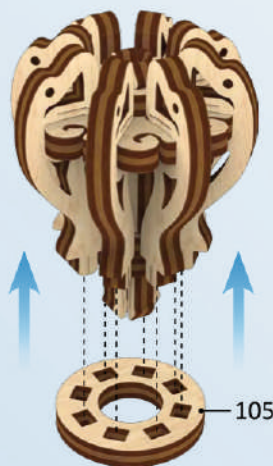

5

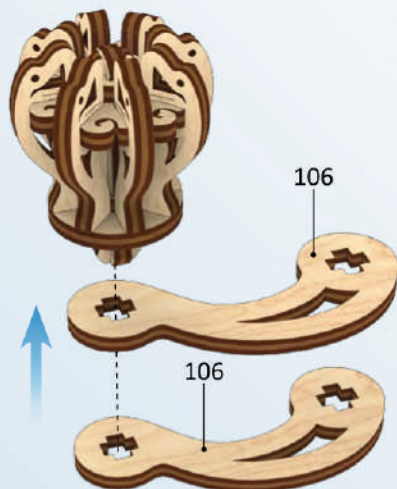

6

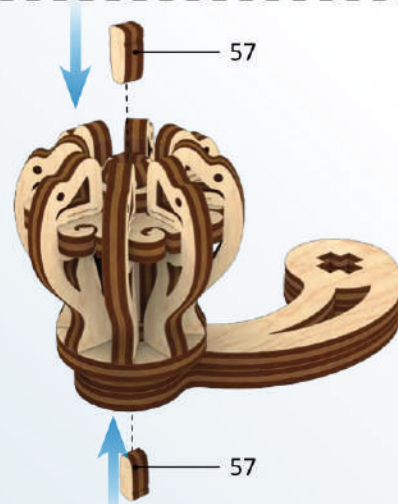

7

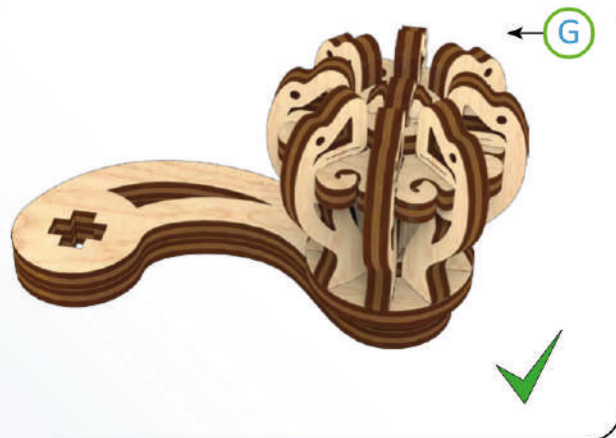



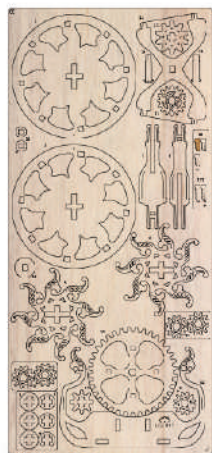

①

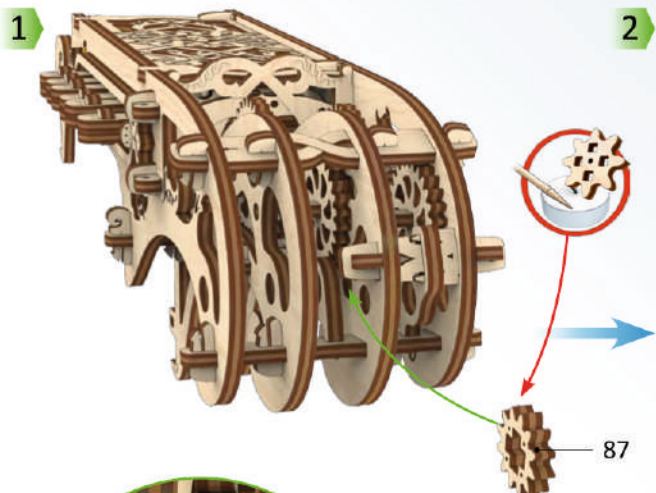

2

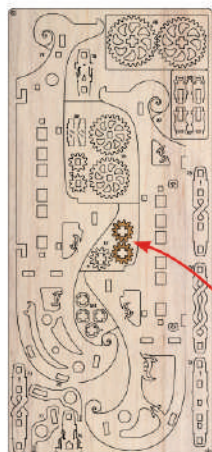

⑤

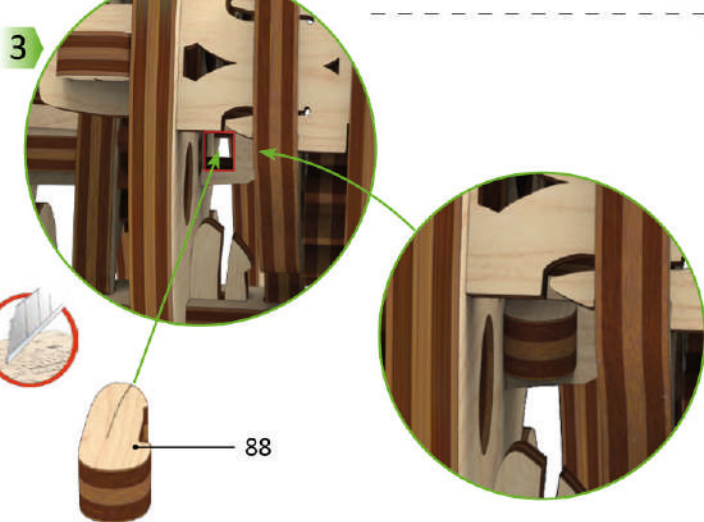

4

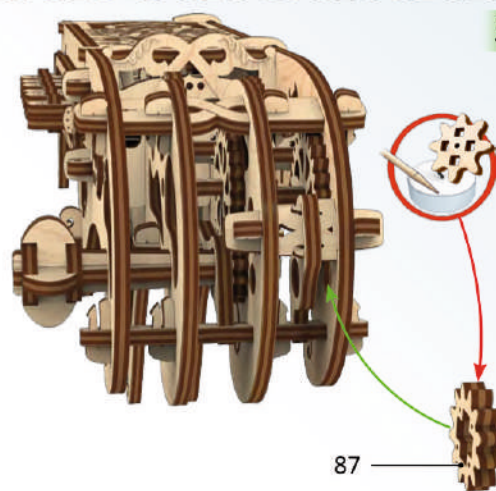

5

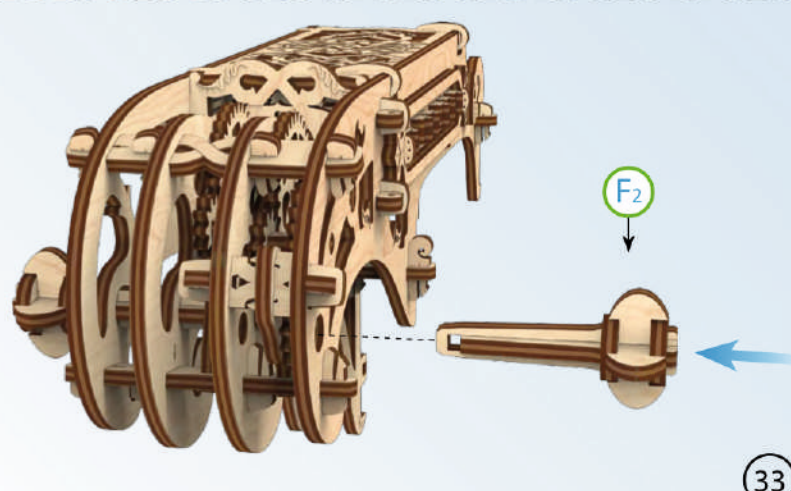

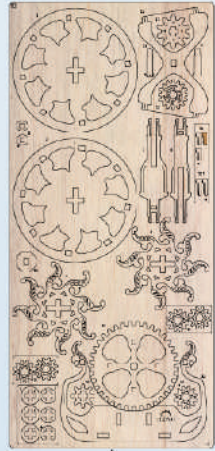

①

1

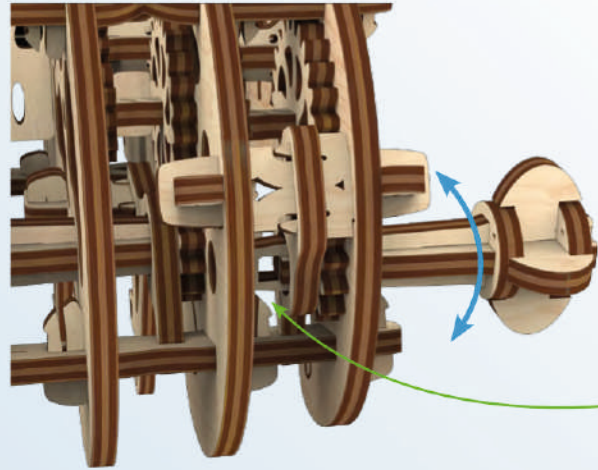

2

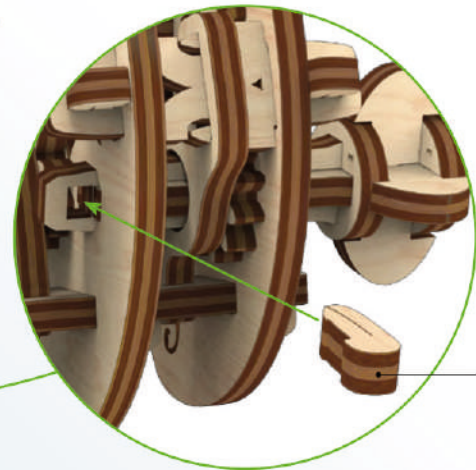

88

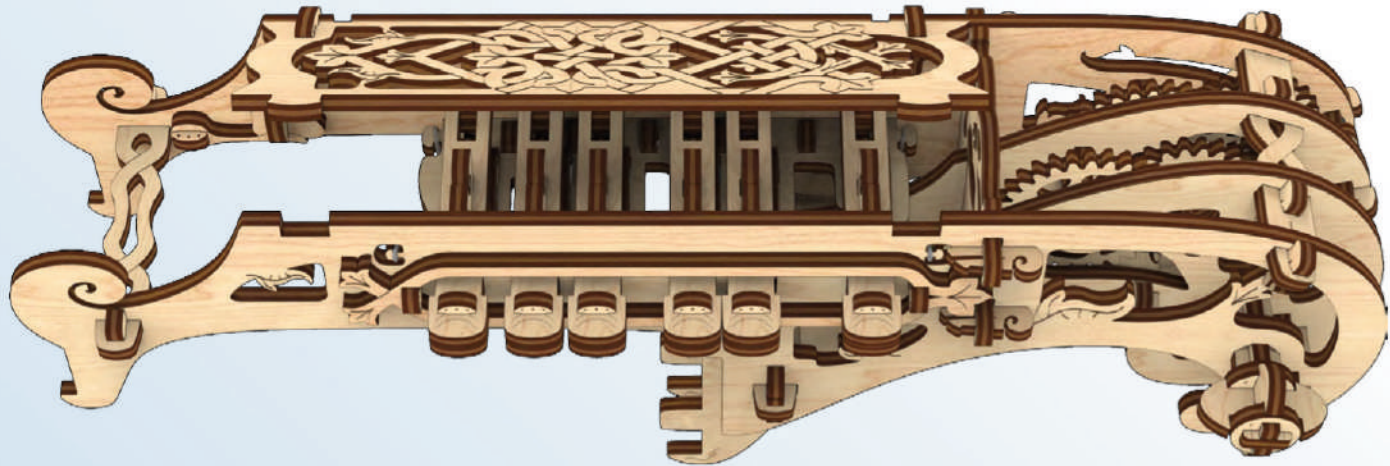

← H



1

H

2

D

1

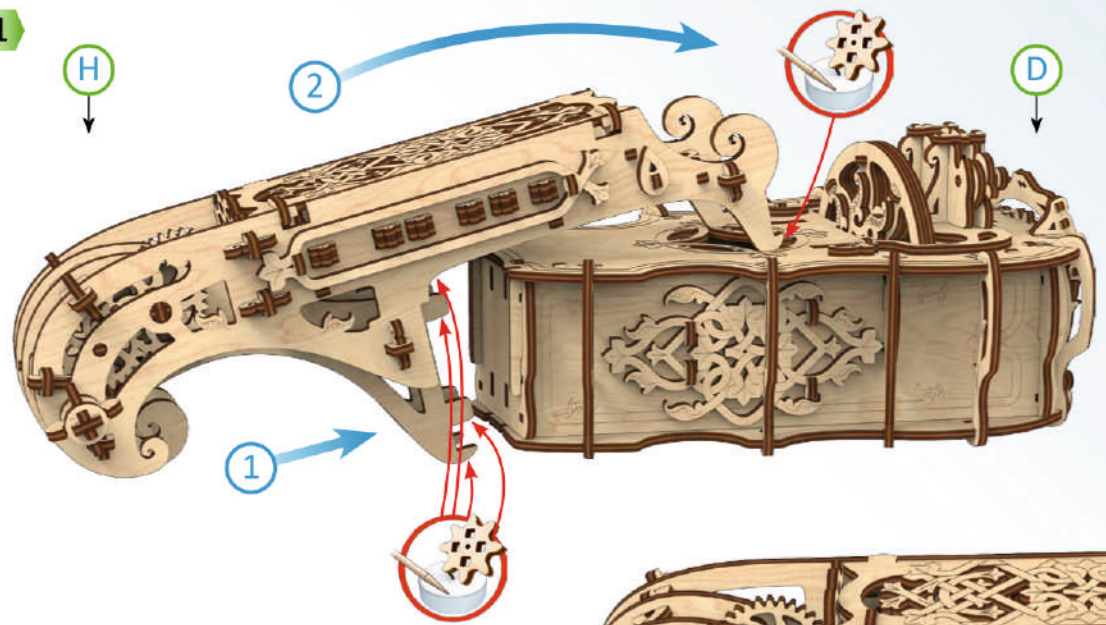

2

KLAC

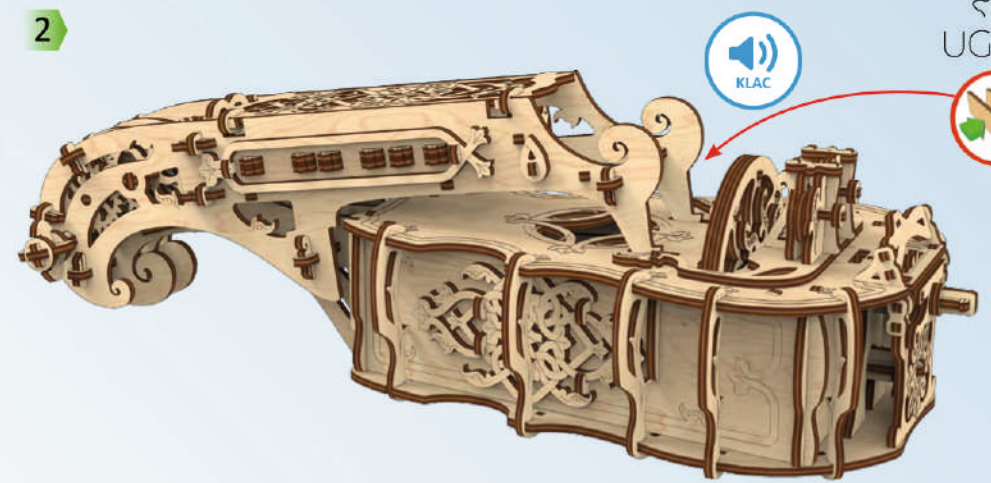

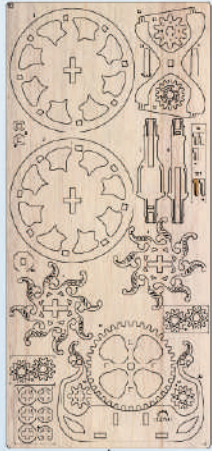

1

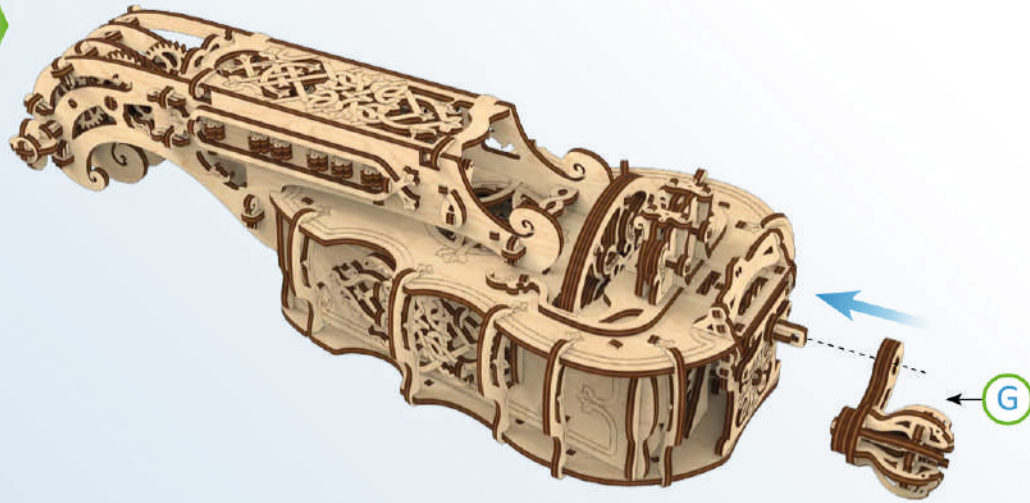

2

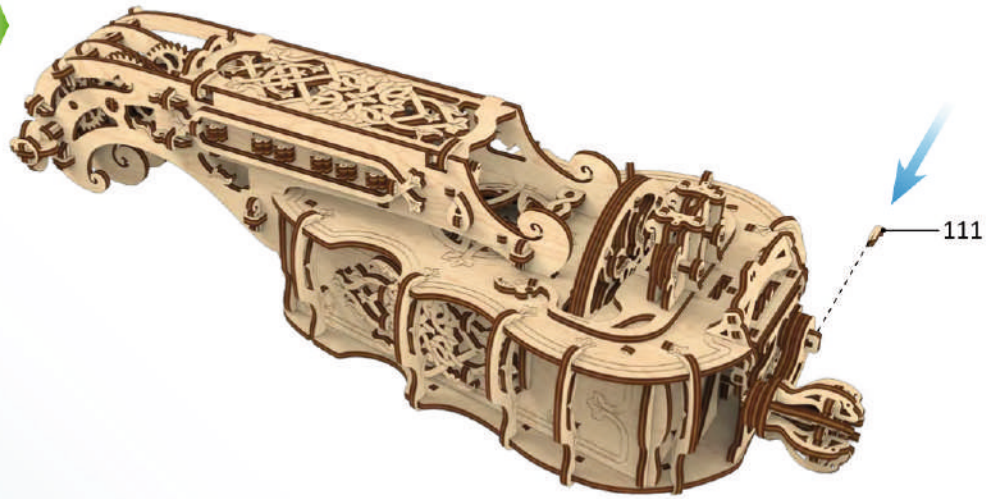

3



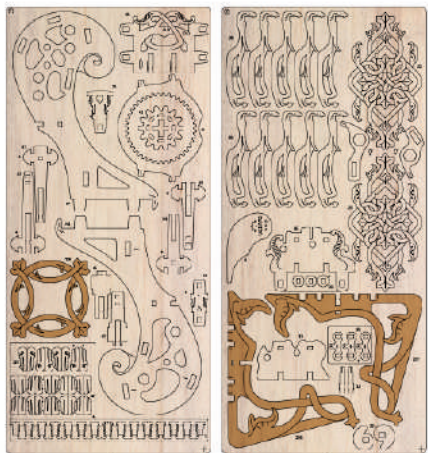

1

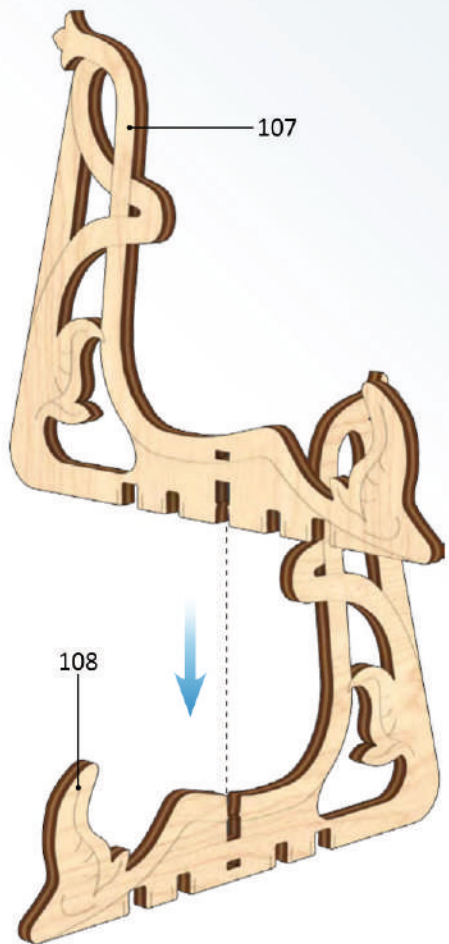

2

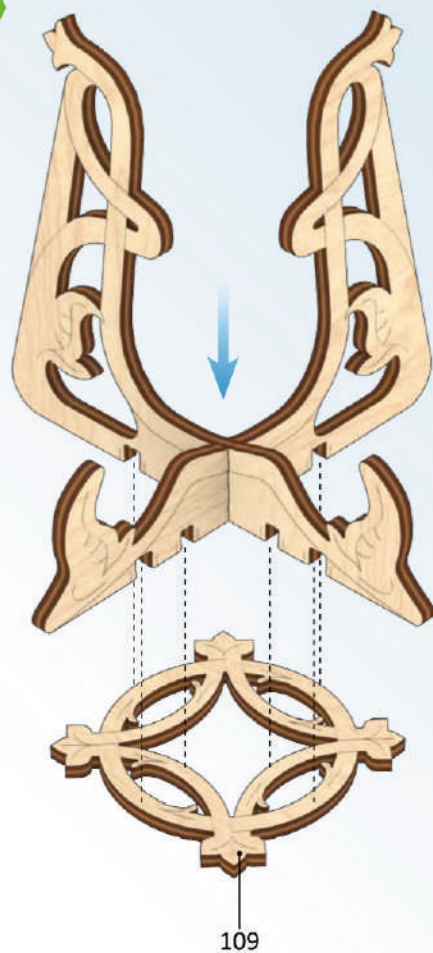

3

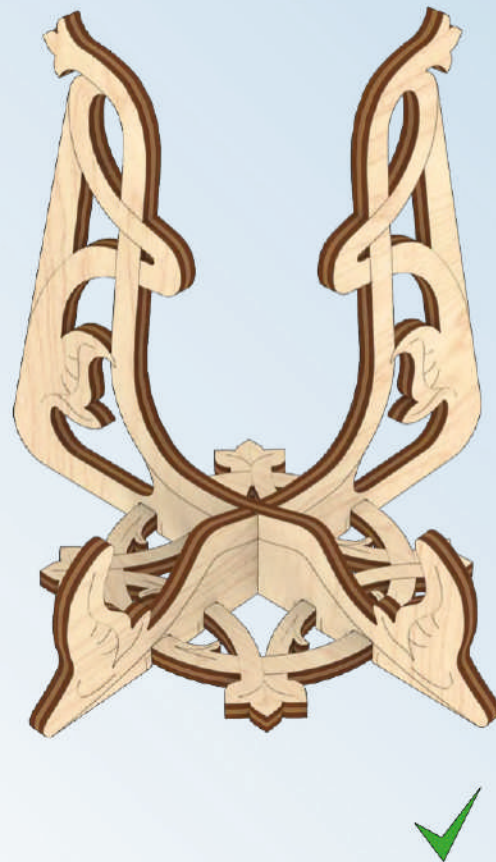

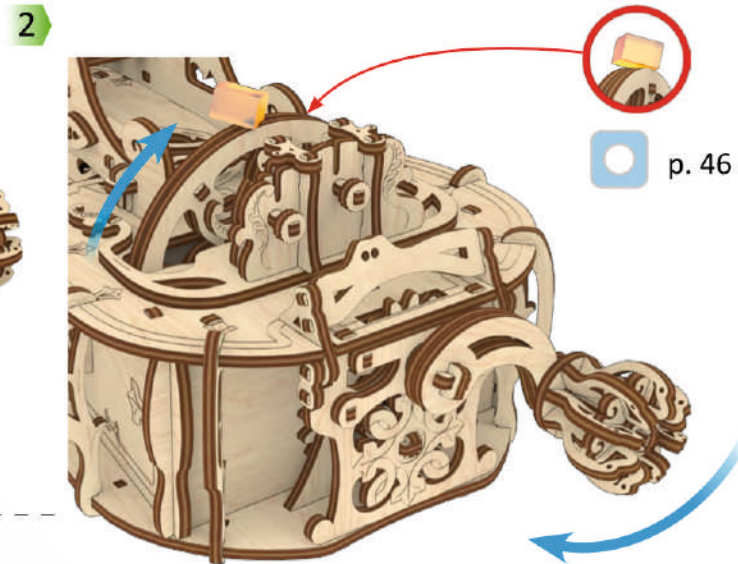
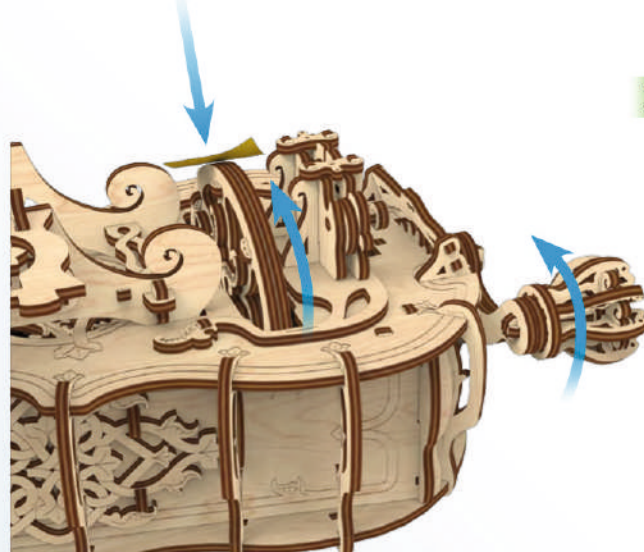
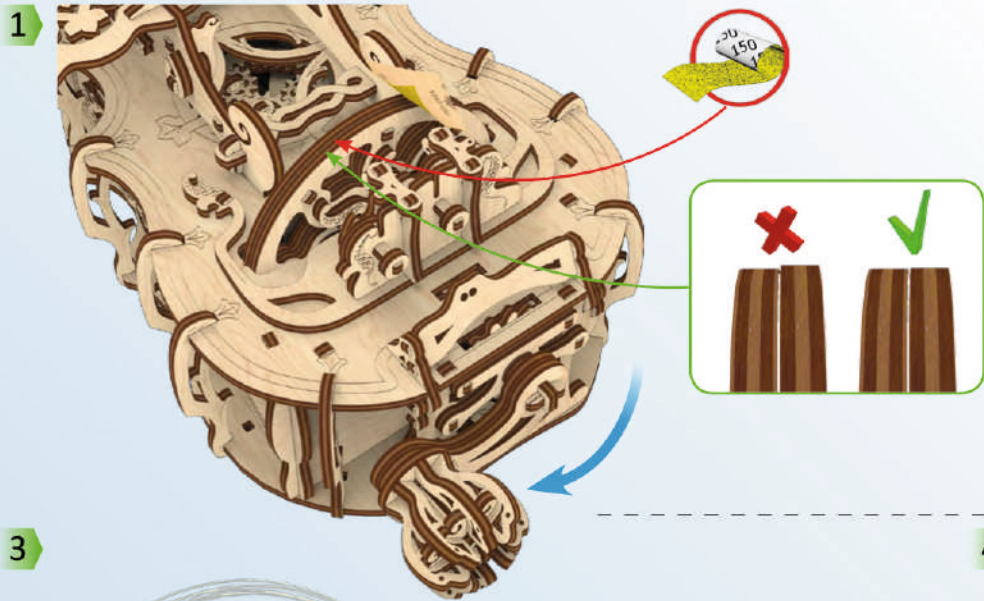

**ENG** Use the fishing line supplied. **UKR** Використовуйте лиску з комплекту. **DEU** Nutzen Sie die Angelschnur aus dem Bausatz. **FRA** Utilisez le fil fourni dans le kit. **POL** Użyj żyłki z zestawu. **SPA** Use el léxico de la unidad. **ITA** Usate la lenza dal kit. **TUR** Takımda olan misinayı kullanınız. **RUS** Используйте леску из комплекта. **KOR** 키트에서 낚시 줄을 사용합니다. **CHI** 请使用提供的钓鱼线。

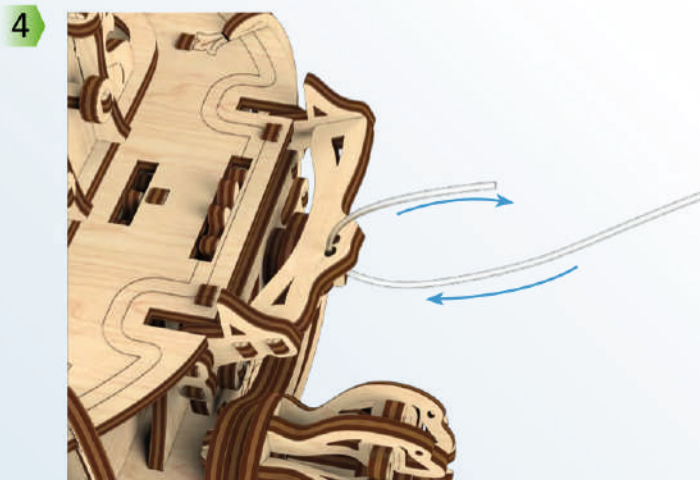

**ENG** Attention! Do not confuse. Attention! The set includes rosin - it is used to increase the friction of the treated surface of the part! **UKR** Увага! Не переплутайте. У набрі є канифоль, для підвищення тертя поверхнь. **DEU** Achtung! Verwechslungsgefahr. Achtung! Kolophonium im Lieferumfang – wird dazu verwendet die Reibung der damit behandelten Oberflächen zu erhöhen. **FRA** Attention! Ne pas confondre. Attention! Dans la boîte est inclus de la résine (colophane) - utilisée pour augmenter le frottement de la surface traitée! **POL** Uwaga: Nie pomył się! Uwaga: Zestaw zawiera kalafonię, używaną do zwiększenia tarcia na powierzchni elementu. **SPA** ¡Atención! No se debe confundir. ¡Atención! El paquete incluye la colofonia - se utiliza para aumentar la fricción de la superficie tratada de la pieza! **ITA** Attenzione! Non confondere. Attenzione! Il set include colofonia - da utilizzare per aumentare l'attrito della superficie trattata! **TUR** Dikkatlice inceleyiniz lütfen / Karışıklığa karşı dikkat! Dikkat! Komple set reçine içerir - işlenmiş parça yüzeyinin sürtünmesini arttırmak için kullanılır! **RUS** Внимание! Не перепутайте. В комплект входит канифоль, для увеличения поверхностного трения. **KOR** 주의! 혼동하지 말 것. 주의! 세트안에 부품 표면의 마찰력을 높이기 위한 송진가루가 포함되어 있음. **CHI** 注意! 不要混淆. 注意! 该组合包含松香-它用来提高处理过的部件表面的摩擦!

1

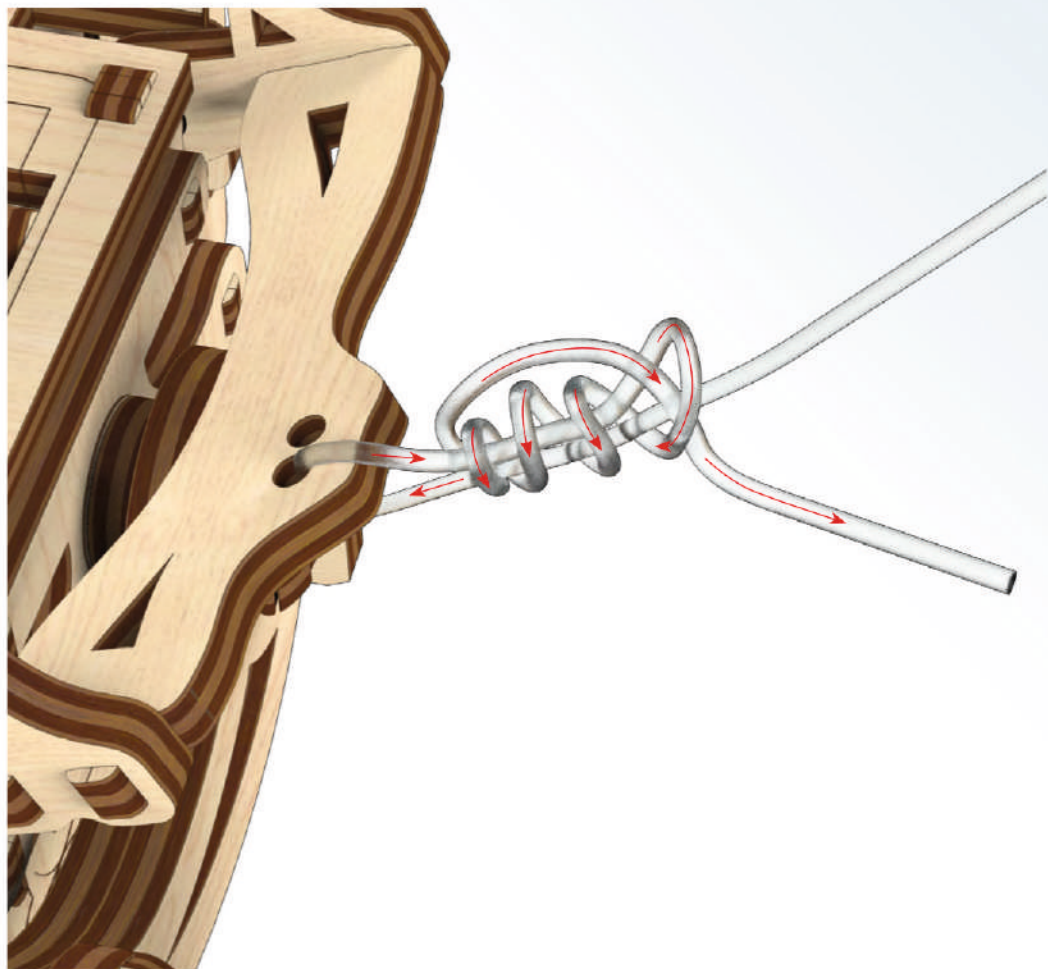

2

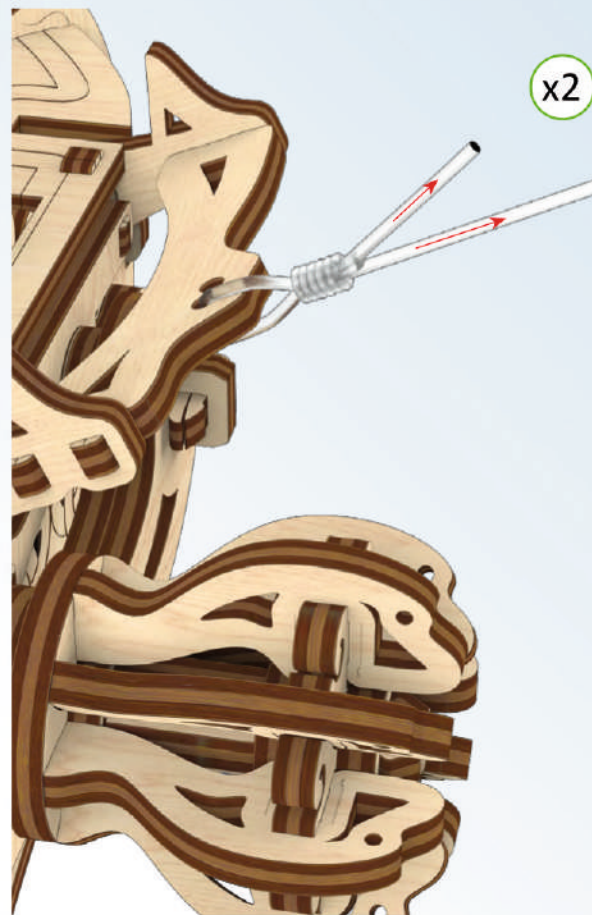

3

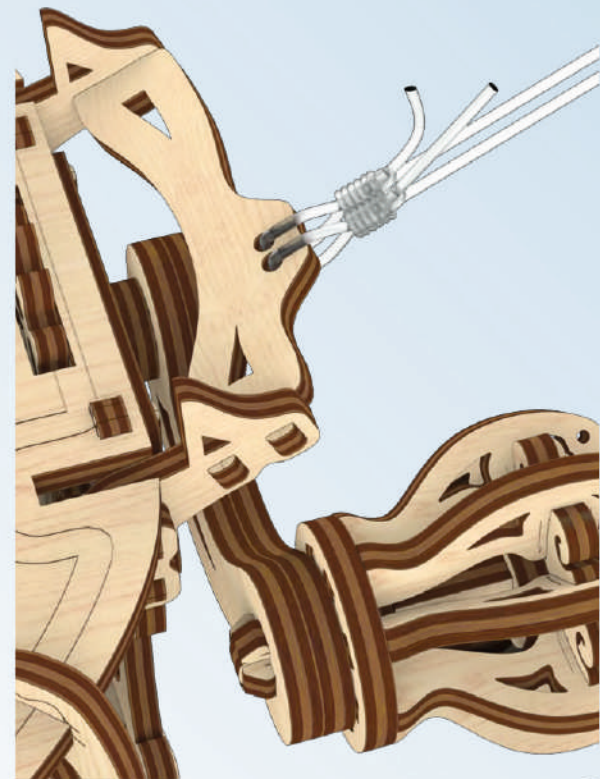

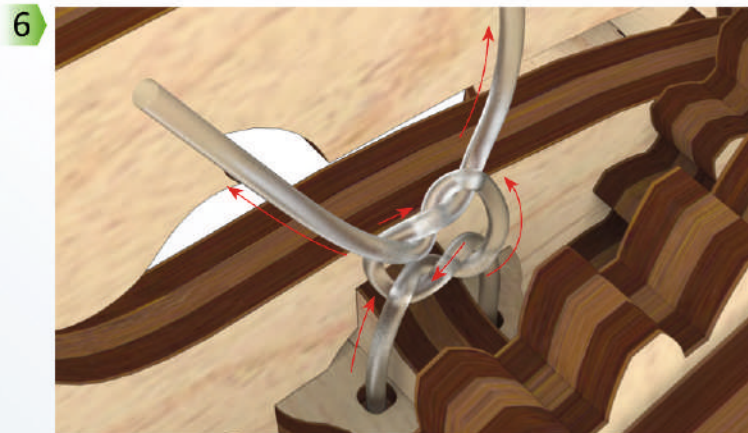
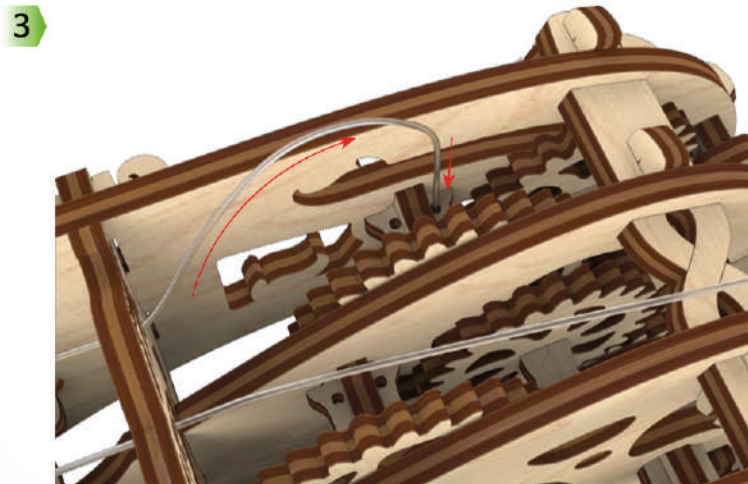



7

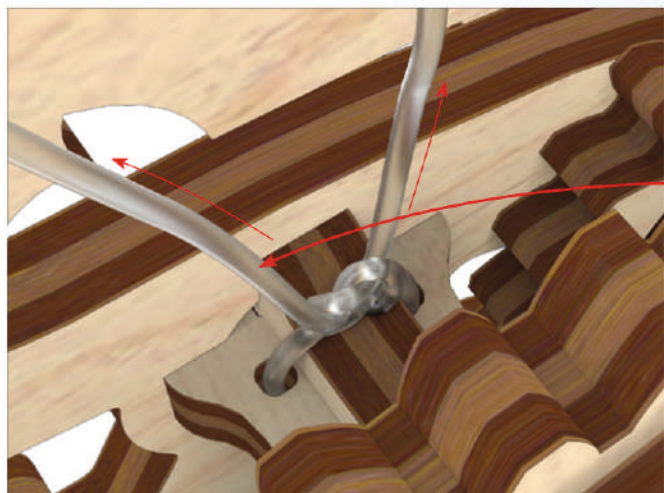

8

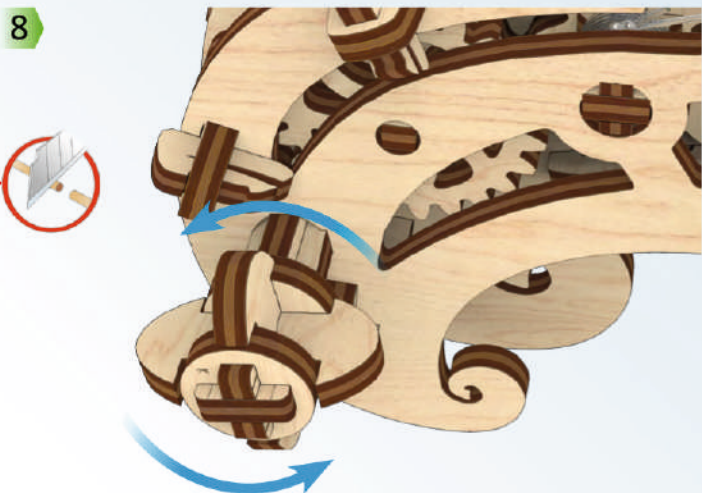

9

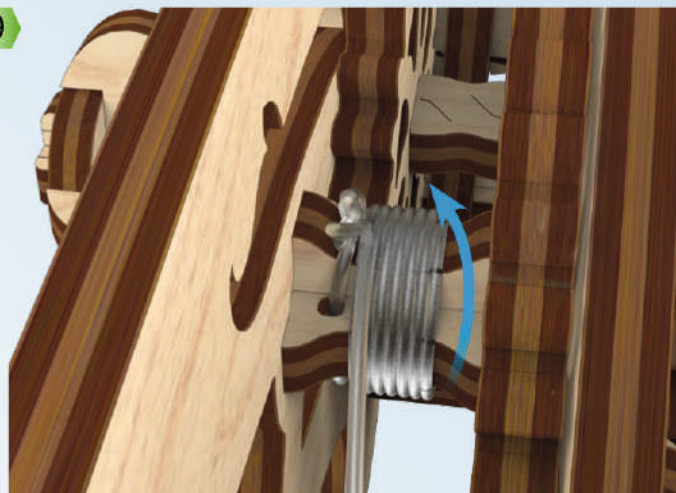

10

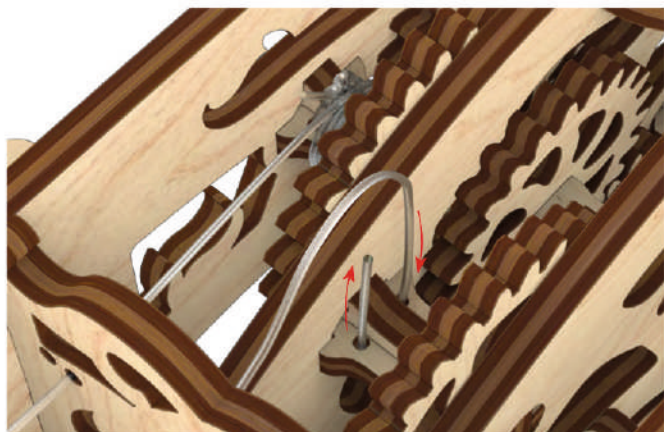

11

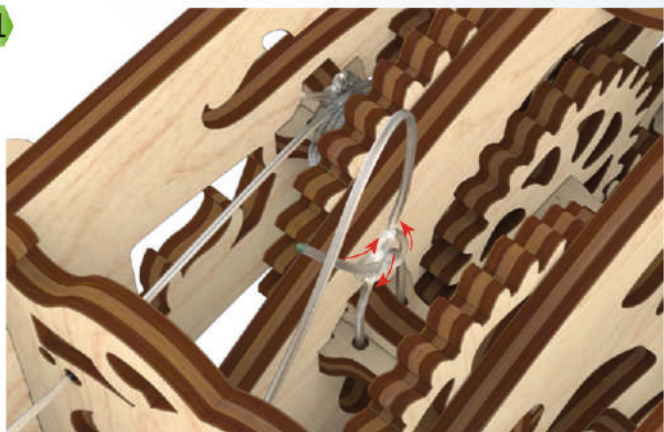

12





[www.ugearsmodels.com/hurdy-gurdy](http://www.ugearsmodels.com/hurdy-gurdy)

13

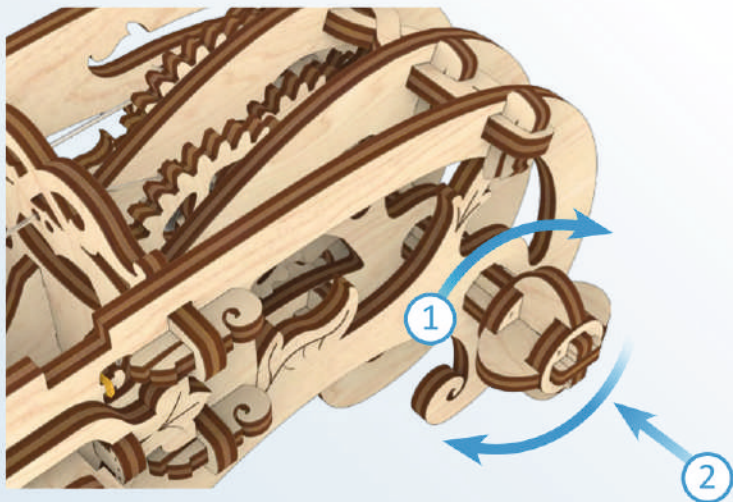

14

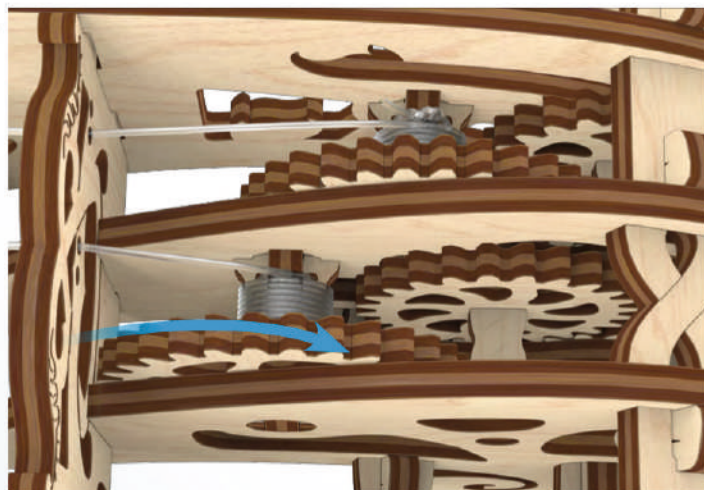

15

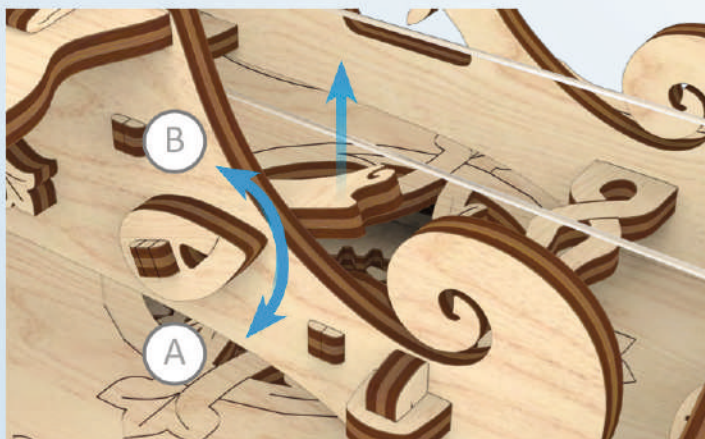

16

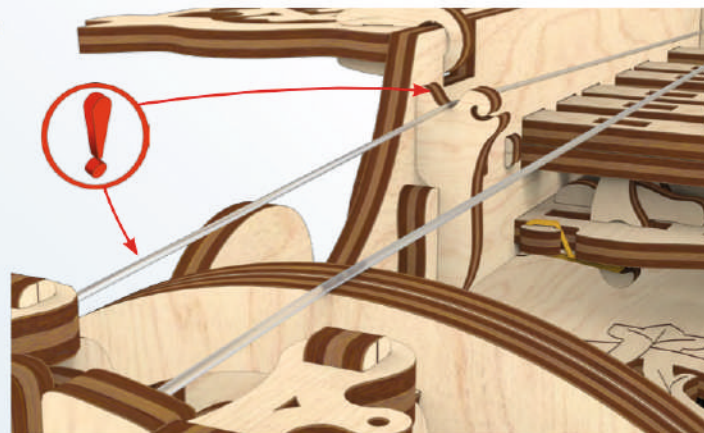

1

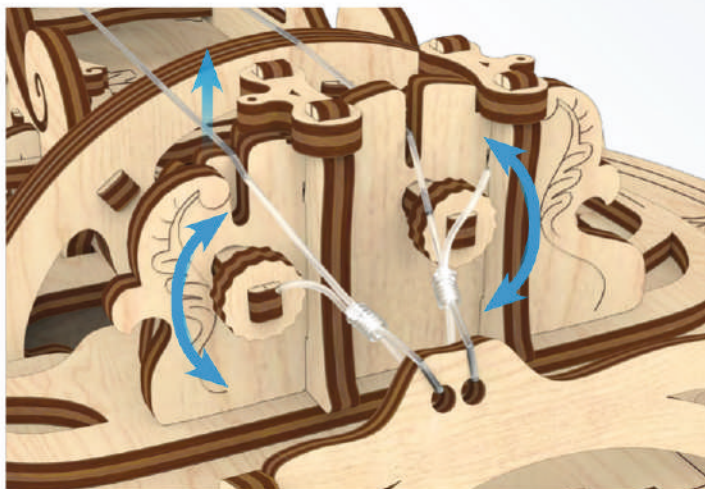

[www.ugearsmodels.com/hurdy-gurdy](http://www.ugearsmodels.com/hurdy-gurdy)

2

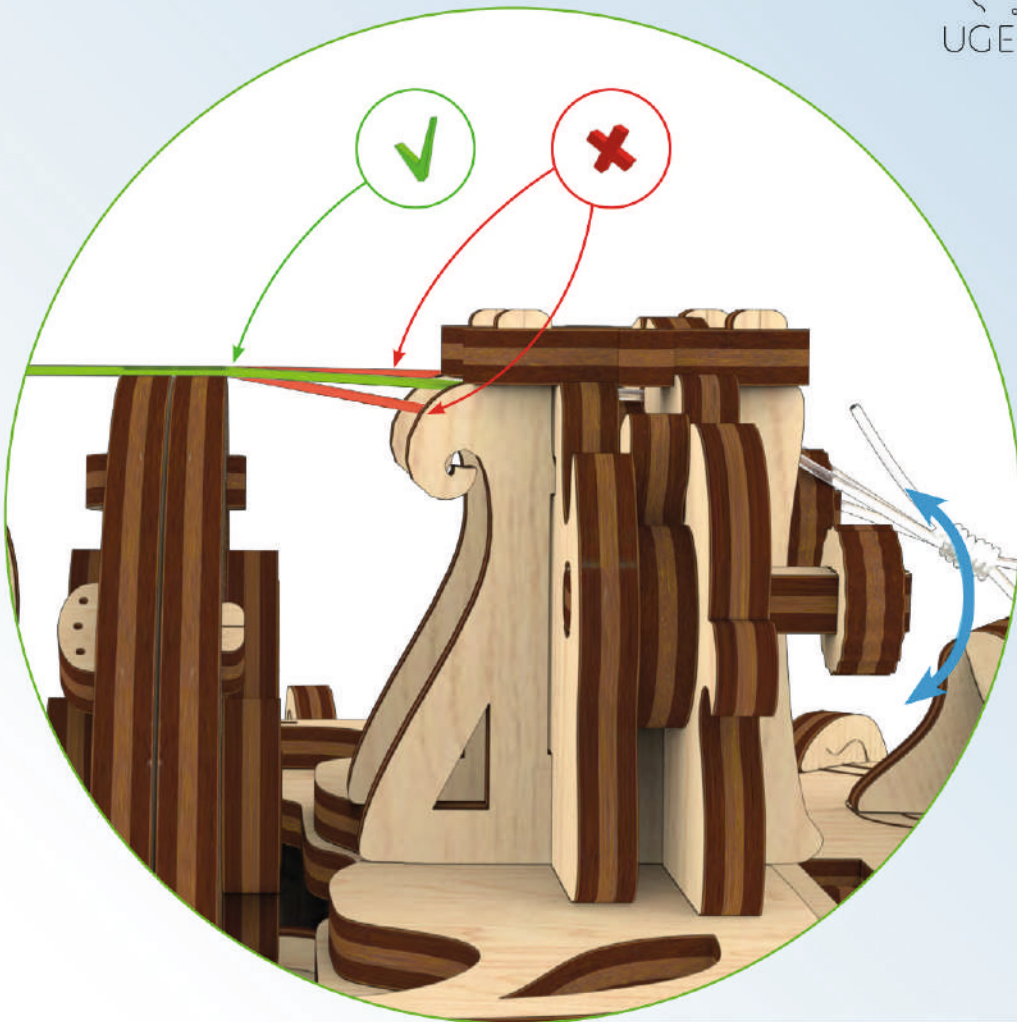
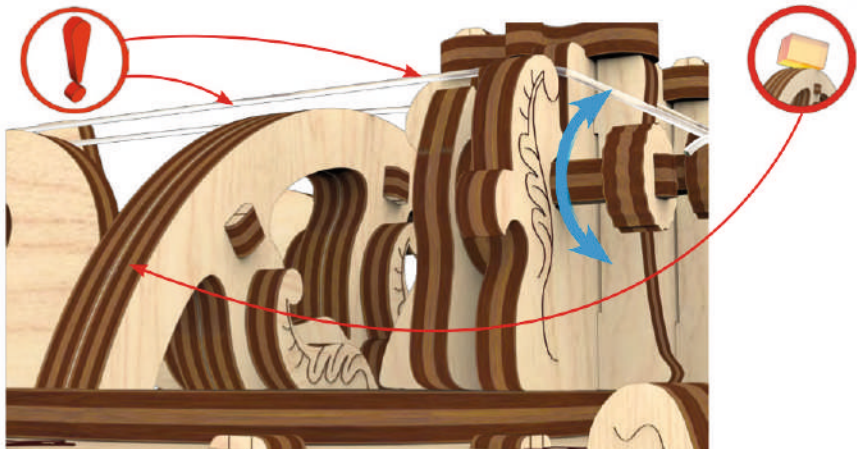

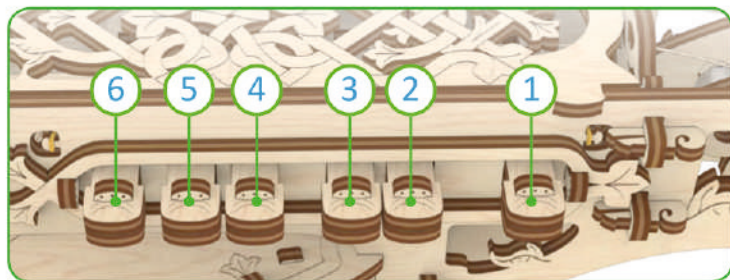
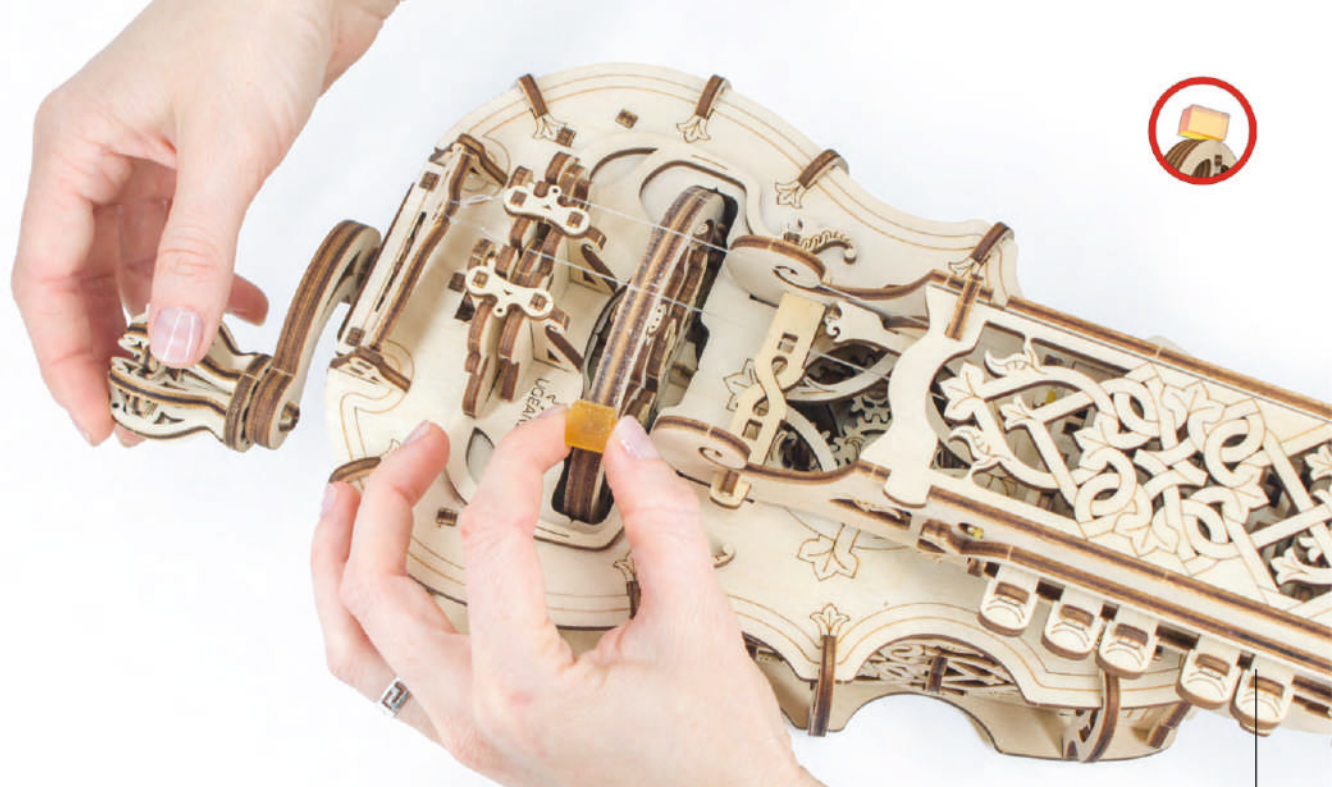

0



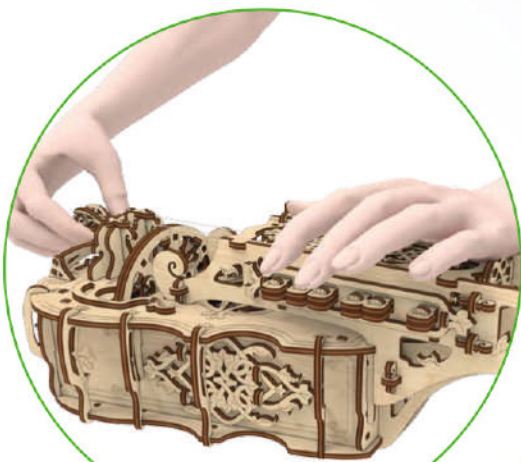

0



1



2



3



4



5

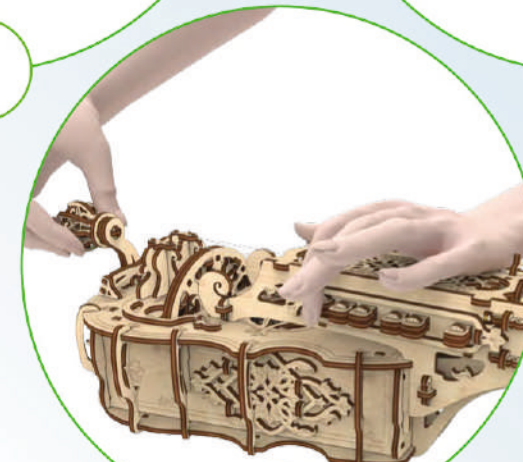

6



[www.ugearmodels.com/hurdy-gurdy](http://www.ugearmodels.com/hurdy-gurdy)

### Ode to Joy



### Branle des Sabots



# Medieval Rock'n'Roll



5 4 3 2 3 3    5 5 4 3    5 4 3 2 4 4 2 0    5 4 3 2 3 3 5 5 4 3



5 4 3 2 3 3    1 3 3 2 3    4 3 5 3 6 6 5 4    5 5 4 3 4 4 3 0



4 3 5 3 6    6 5 4    1 3 3 2 3    5 5 4 3 4 4 3 0



**ENG** Thanks for following along on this journey with us. **UKR** Дякуємо, що ви пройшли цей шлях з нами. **DEU** Vielen Dank, dass Sie diesen Weg mit uns gegangen sind. **FRA** Merci de nous avoir accompagnés tout au long de ces étapes. **POL** Dziękujemy, że razem z nami pokonałeś tę drogę! **SPA** Gracias por haber recorrido el camino con nosotros. **ITA** Grazie per aver fatto uesto percorso con noi. **TUR** Bizimle bu yolu geçtiğiniz için teşekkür ederiz. **RUS** Спасибо, что вы прошли этот путь с нами. **KOR** UGEARS와 함께해 주셔서 감사합니다. **CHI** 感谢您参与有趣的模型拼装过程。

[ugearsmodels.com](http://ugearsmodels.com)